

User's Manual

EPIA-MII Mini-ITX Mainboard

Version 1.50
August 26, 2004

Copyright

Copyright © 2004 VIA Technologies Incorporated. All rights reserved. No part of this document may be reproduced, transmitted, transcribed, stored in a retrieval system, or translated into any language, in any form or by any means, electronic, mechanical, magnetic, optical, chemical, manual or otherwise without the prior written permission of VIA Technologies Incorporated.

Trademarks

Windows CE™, Windows XP™, Windows 2000™, Windows ME™, Windows 98™ and plug and play™ are registered trademarks of Microsoft Corporation.

PS/2 is a registered trademark of IBM Corporation.

AwardBIOS is a registered trademark of Phoenix Technologies Ltd.

All trademarks are the property of their respective holders.

Disclaimer

No license is granted, implied or otherwise, under any patent or patent rights of VIA Technologies. VIA Technologies make no warranties, implied or otherwise, in regard to this document and to the products described in this document. The information provided in this document is believed to be accurate and reliable as of the publication date of this document. However, VIA Technologies assume no responsibility for any errors in this document. Furthermore, VIA Technologies assume no responsibility for the use or misuse of the information of this document and for any patent infringements that may arise from the use of this document. The information and product specifications within this document are subject to change at any time, without notice and without obligation to notify any person of such change.

FCC-B Radio Frequency Interference Statement

This equipment has been tested and found to comply with the limits for a class B digital device, pursuant to part 15 of the FCC rules. These limits are designed to provide reasonable protection against harmful interference when the equipment is operated in a commercial environment. This equipment generates, uses and can radiate radio frequency energy and, if not installed and used in accordance with the instruction manual, may cause harmful interference to radio communications. Operation of this equipment in a residential area is likely to cause harmful interference, in which case the user will be required to correct the interference at his own expense.

Notice 1

The changes or modifications not expressly approved by the party responsible for compliance could void the user's authority to operate the equipment.

Notice 2

Shielded interface cables and A.C. power cord, if any, must be used in order to comply with the emission limits.



Tested To Comply
With FCC Standards
FOR HOME OR OFFICE USE

Safety Instructions

1. Always read the safety instructions carefully.
2. Keep this User's Manual for future reference.
3. Keep this equipment away from humidity.
4. Lay this equipment on a reliable flat surface before setting it up.
5. The openings on the enclosure are for air convection hence protects the equipment from overheating. **DO NOT COVER THE OPENINGS.**
6. Make sure the voltage of the power source and adjust properly 110/220V before connecting the equipment to the power inlet.
7. Place the power cord in such a way that people cannot step on it. Do not place anything over the power cord.
8. Always unplug the power cord before inserting any add-on card or module.
9. All cautions and warnings on the equipment should be noted.
10. Never pour any liquid into the opening. Liquid can cause damage or electrical shock.
11. If any of the following situations arises, get the equipment checked by a service personnel:
 - The power cord or plug is damaged
 - Liquid has penetrated into the equipment
 - The equipment has been exposed to moisture
 - The equipment has not work well or you can not get it work according to User's Manual.
 - The equipment has dropped and damaged
 - If the equipment has obvious sign of breakage
12. **DO NOT LEAVE THIS EQUIPMENT IN AN ENVIRONMENT UNCONDITIONED, STORAGE TEMPERATURE ABOVE 60°C (140°F), IT MAY DAMAGE THE EQUIPMENT.**

CAUTION: Explosion or serious damage may occur if the battery is incorrectly replaced. Replace only with the same or equivalent type recommended by the manufacturer.

Box Contents

- 1 x VIA Mainboard
- 1 x Quick Installation Guide
- 1 x Floppy Ribbon Cable
- 1 x ATA-66/100/133 IDE Ribbon Cable
- 1 x I/O Bracket
- 1 x Driver Utilities CD

Table of Contents

Chapter 1: Specifications	1-1
Mainboard Specifications	1-2
Mainboard Layout	1-4
Back Panel Ports	1-6
Slots	1-6
Onboard Connectors and Jumpers	1-7
Chapter 2: Installation	2-1
CPU Installation	2-2
Memory Module Installation	2-4
Connecting the Power Supply	2-6
Back Panel Ports	2-7
Connectors	2-11
Jumpers	2-19
Slots	2-20
Chapter 3: BIOS Setup	3-1
Entering Setup	3-2
Control Keys	3-2
Getting Help	3-3
The Main Menu	3-4
Standard CMOS Features	3-6
Advanced BIOS Features	3-8
Advanced Chipset Features	3-12
Integrated Peripherals	3-14
Power Management Setup	3-18
PnP / PCI Configurations	3-24
PC Health Status	3-27
Frequency / Voltage Control	3-28
Load Fail-Safe Defaults	3-30
Load Optimized Defaults	3-31
Set Supervisor / User Password	3-32
Save & Exit Setup	3-34
Exit Without Saving	3-35
Chapter 4: Driver Installation	4-1
Driver Utilities	4-2
CD Content	4-3

Chapter

1

Specifications

The ultra-compact and highly intergrated VIA EPIA-MII Mini-ITX Mainboard is the smallest form factor mainboard specification available today, developed by VIA Technologies, Inc. as part of the company's open industry-wide total connectivity initiative. The mainboard enables the creation of an exciting new generation of small, ergonomic, innovative and affordable embedded systems. Through high level of integration, mini-ITX only occupy 66% of the size of FlexATX mainboard form factor. The mainboard comes with an embedded VIA Processor, boasting ultra low power consumption and cool, quiet operation.

This chapter includes the following sections:

Mainboard Specifications	1-2
Mainboard Layout	1-4
Back Panel Ports	1-6
Slots	1-6
Connectors / Jumpers	1-7

Mainboard Specifications

CPU

- VIA C3 / EDEN EBGA Processor (onboard)
- Enhanced Ball Grid Array Package (EBGA)
- Internal L1 128KB and L2 64KB cache memory

Chipset

- VIA CLE266 North Bridge
- VT8235 South Bridge

Memory

- 1 x DDR266 DIMM socket (up to 1 GB)

Expansion Slots

- 1 x PCI

Graphics

- Integrated VIA Castlerock AGP graphics

Audio

- VT1616, six-channel AC'97 Codec

Onboard IEEE 1394 (optional)

- VIA VT6307S IEEE 1394

LAN

- VIA VT6103 10/100 Base-T Ethernet PHY

IDE

- 2 X UltraDMA 66/100/133 Connectors

OnModule CardBus/CF

- RICOH 476II

LVDS (optional)

VIA VT1631 LVDS Transmitter

Back Panel I/O Ports

- 1 x PS2 mouse port
- 1 x PS2 keyboard port
- 1 x VGA port
- 1 x S-Video port
- 1 x RCA port (SPDIF or TV-out)
- 1 x RJ-45 LAN port
- 2 x USB 2.0/1.1 ports
- 1 x 1394 port
- 1 x Cardbus slot & CF slot
- 1 x Serial port
- 3 x Audio jacks: line-out, line-in and mic-in

Onboard I/O Connectors

- 1 x USB 2.0/1.1 connector (USB 2.0 support included in South Bridge)
- 1 x 1394 connector (optional)
- 1 x CD Audio-in connector
- 1 x Front audio connector
- 1 x FIR connector
- 1 x KBMS connector
- 1 x Wake-on-LAN connector
- 3 x Fan connectors (CPU Fan, System Fan, Fan 3)
- 1 x LVDS connector (optional)
- 1 x Serial port connector for second COM port
- 1 x LPT port connector
- 1 x SMBus connector
- 1 x Video feature connector support (optional)

BIOS

- Award BIOS on 2/4Mbit flash memory

Form Factor

- 17 cm X 17 cm Mini-ITX (6 layers)

Mainboard Layout

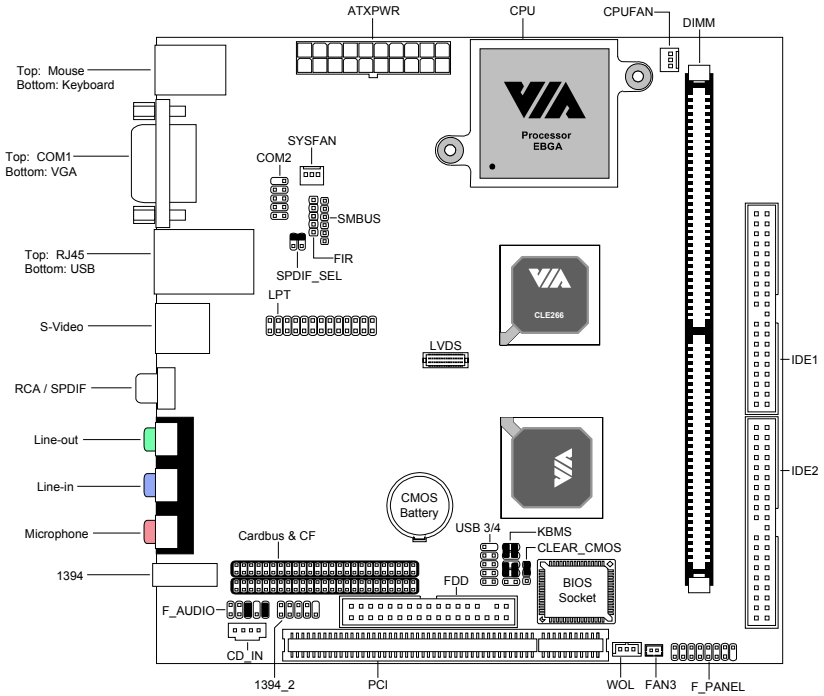

Back Panel

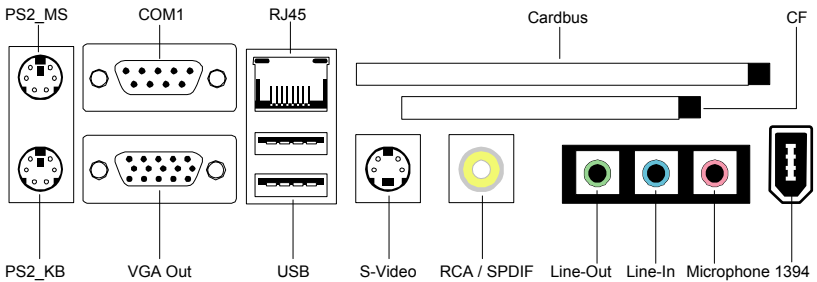

Add-On Module

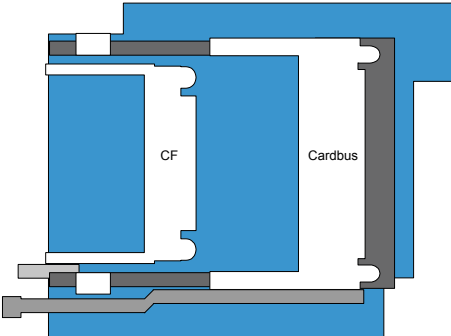

Placement of Add-On Module

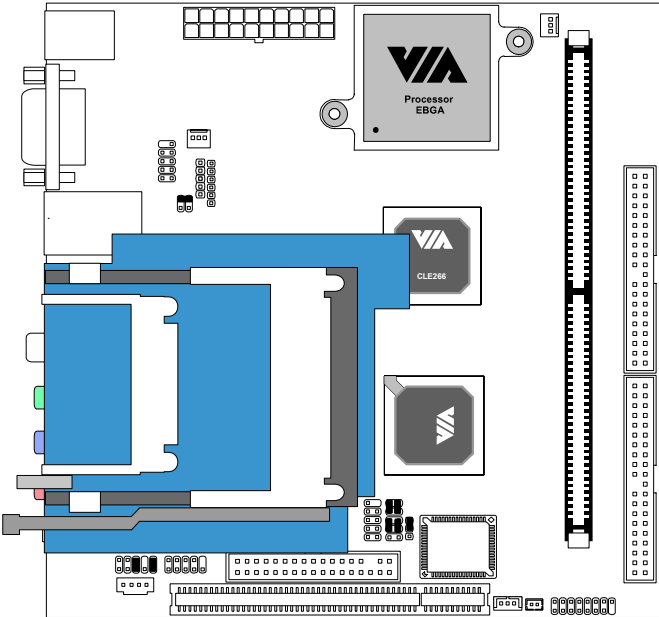

Back Panel Ports

Port	Description	Page
1394	IEEE1394 (Firewire) port	2-9
Audio Jacks	Line-Out, Line-In, Microphone	2-9
Cardbus Slot	PCMCIA Type II card slot	2-9
CF Slot	CF Slot	2-9
COM 1	Serial port	2-9
PS2-MS	PS2 mouse port	2-7
PS2-KB	PS2 keyboard port	2-7
RCA_JACK	RCA Video or SPDIF jack	2-8
RJ45	10/100 NIC port	2-8
S-VIDEO	S-Video Port	2-8
USB 1-2	Universal Serial Bus ports 1 - 2	2-8
VGA Out	VGA out port	2-8

Slots

Slot	Description	Page
DIMM 1	Memory module slot	2-4
PCI	Expansion card slot	2-19

Onboard Connectors and Jumpers

Connector/Jumper	Description	Page
1394_2	IEEE 1394 connector	2-16
ATXPWR	ATX power cable connector	2-6
CD_IN	Onboard CD audio cable connector	2-15
CLEAR_CMOS	Jumper to reset CMOS settings to default	2-18
COM2	Second serial port connector	2-14
F_AUDIO	Front audio connector	2-15
F_PANEL	Case connector	2-11
Fans	CPU Fan, System Fan, Fan 3	2-2
FDD	Floppy disk drive connector	2-14
FIR	Infrared Radiation connector	2-12
SMBUS	SM Bus connector	2-16
IDE 1 & 2	IDE hard disk drive connectors	2-10
KBMS	CIR/PS2(EXT_KBMS) connector	2-12
LPT	LPT port connector	2-16
LVDS	LVDS connector	2-17
SPDIF_SEL	Sony Philips Digital Interface jumper	2-18
USB 3/4	Universal Serial Bus connector	2-13
WOL	Wake On LAN connector	2-13

Chapter 2

Installation

This chapter provides you with information about hardware setup procedures. While installing the mainboard, carefully hold the components and closely follow the installation procedures. Some components may be damaged if they are installed incorrectly.

It is recommended to use a grounded wrist strap before handling computer components. Static electricity can damage some components.

This chapter includes the following sections:

CPU	2-2
Memory Module Installation	2-4
Connecting the Power Supply	2-6
Back Panel Ports	2-7
Connectors	2-11
Jumpers	2-19
Slots	2-20

CPU

The VIA EPIA-MII Mini-ITX Mainboard includes an embedded VIA Eden Processor or VIA C3™ E-Series Processor. The CPUFAN (CPU fan) and SYSFAN (system fan) run on +12V and maintain system cooling. When connecting the wire to the connectors, always be aware that the red wire is the Positive and should be connected to the +12V. The black wire is Ground and should be connected to GND. Both CPU and System fan connectors have sensors to detect fan speed.

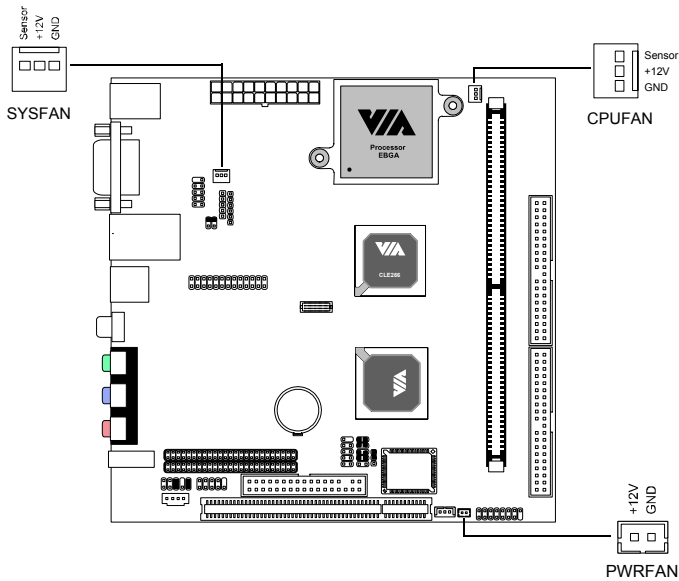

The VIA C3™ E-Series Processor

With low power consumption and advanced thermal dissipation properties, the embedded VIA C3™ E-Series requires only a small fan to guarantee performance and reliability. Ensure that the CPU Fan Connector is correctly installed as shown.

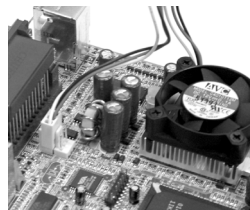

The VIA Eden Processor

Providing ultra-low power consumption and advanced thermal dissipation properties, the VIA Eden Processor features a fanless design. The VIA Eden Processor requires only a heatsink as shown.

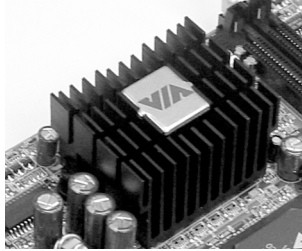

Warning: This motherboard is not designed to support overclocking. Any attempt to operate beyond product specifications is not recommended. We do not guarantee the damages or risks caused by operation beyond product specifications.

Memory Module Installation

The VIA EPIA-MII Mini-ITX Mainboard provides one DIMM slot for DDR266 SDRAM memory modules.

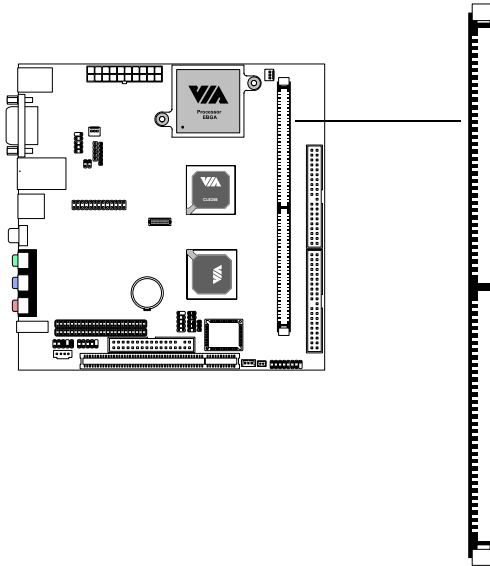

DDR SDRAM Module Installation Procedures

1. Push the white retaining latches at either end of the DIMM slot outwards.
2. Align the DDR SDRAM module with the corresponding notches on the DIMM slot. The modules will only fit if placed in the correct position.
3. With both hands, press the DDR SDRAM module down into the DIMM slot so that the white retaining latches rotate up and secure the module in place (see picture below).

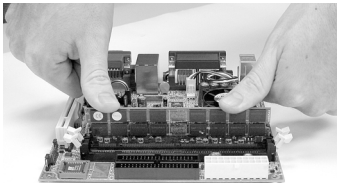

Available DDR SDRAM Configurations

Refer to the table below for available DDR SDRAM configurations on the mainboard.

Slot	Memory Module	Total Memory
DIMM (Bank 0 & 1)	64MB, 128MB, 256MB, 512MB, 1GB	64 MB - 1 GB
Maximum System Memory Supported		64 MB - 1 GB

Connecting the Power Supply

The VIA EPIA-MII Mini-ITX Mainboard requires an ATX power supply to be connected. Before inserting the power supply connector, always make sure that all components are installed correctly to ensure that no damage will be caused.

ATX 20-Pin Power Connector

To connect the ATX power supply, make sure the plugs of the power supply are inserted in the proper orientation and the pins are correctly aligned. Then, push down the power supply plug firmly into the connector.

Pin	Signal
1	3.3V
2	3.3V
3	GND
4	5V
5	GND
6	5V
7	GND
8	PW_OK
9	5V_SB
10	12V
11	3.3V
12	-12V
13	GND
14	PS_ON
15	GND
16	GND
17	GND
18	NC
19	5V
20	5V

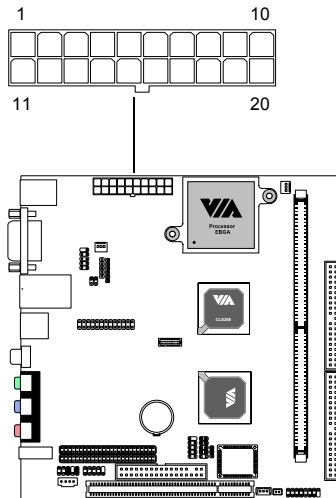

Back Panel Ports

The back panel has the following ports:

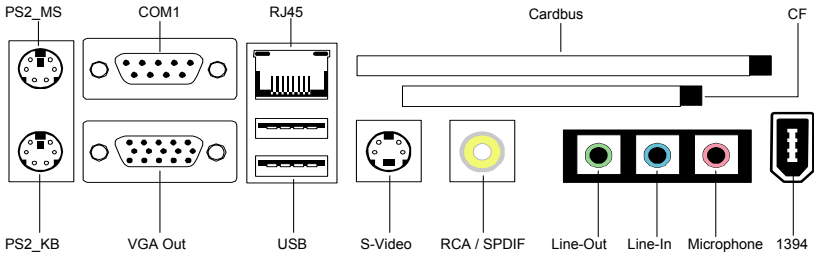

Mouse Port: PS2_MS

The mainboard provides a standard PS/2 mouse connector for attaching a PS/2 mouse. You can plug a PS/2 mouse directly into this connector. The connector location and pin assignments are as follows.

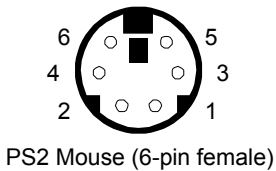

PS2 Mouse (6-pin female)

Pin	Signal	Description
1	Mouse DATA	Mouse data
2	NC	No connection
3	GND	Ground
4	VCC	+5V
5	Mouse Clock	Mouse clock
6	NC	No connection

Keyboard Port: PS2_KB

The mainboard provides a standard PS/2 keyboard connector for attaching a PS/2 keyboard. You can plug a PS/2 keyboard directly into this connector.

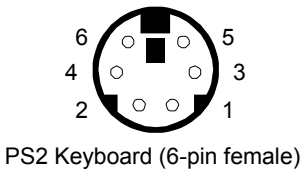

PS2 Keyboard (6-pin female)

Pin	Signal	Description
1	Keyboard DATA	Keyboard data
2	NC	No connection
3	GND	Ground
4	VCC	+5V
5	Keyboard Clock	Keyboard clock
6	NC	No connection

VGA Out

A DB-15 pin female connector that connects to a VGA monitor.

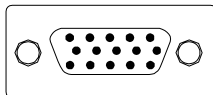

USB Ports

The mainboard provides 2 USB 2.0/1.1 ports (plus 1 pin-header for up to 2 additional USB 2.0/1.1 ports). USB-compatible devices can be plugged directly into these ports.

Pin	Signal	Description
1	VCC	+5V
2	-DATA	Negative Data Channel
3	+DATA	Positive Data Channel
4	GND	Ground

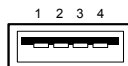

RJ45 10/100 NIC Port

The mainboard provides one standard RJ-45 port for connection to the Local Area Network (LAN). You can connect a network cable to the LAN port.

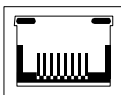

S-Video Port

This port allows S-Video output in NTSC and PAL modes.



RCA Video or S/PDIF Port

This dual function port may be used either as a RCA Video port or as a S/PDIF port. See SPDIF_SEL in the Jumpers section for more details.

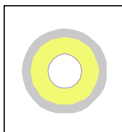

IEEE 1394 Port

The mainboard provides one standard 1394 port. You can connect any 1394 (Firewire) device to this port.



Serial Port: COM1

The mainboard offers one 9-pin male Serial Port connector COM1. You can attach a serial mouse or other serial devices directly to these port.

Pin	Signal	Description
1	DCD	Data Carry Detect
2	SIN	Serial In or Receive Data
3	SOUT	Serial Out or Transmit Data
4	DTR	Data Terminal Ready
5	GND	Ground
6	DSR	Data Set Ready
7	RTS	Request To Send
8	CTS	Clear To Send
9	RI	Ring Indicate

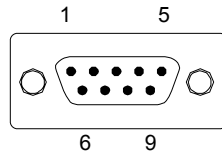

9-Pin Serial Port

Card Slots: PCMCIA, CF

The mainboard comes with an add-on card that provides support for PCMCIA and CF cards. The CF slot supports both type I and type II. These slots are accessed on the same side as the ports.

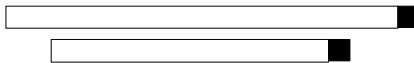

Audio Jacks: Line-In, Line-Out, Microphone

Jack	2-Channel	6-Channel
Line-In	Line in	Rear (Left / Right)
Line-Out	Line out	Front (Left / Right)
Mic	Microphone	Center / Subwoofer

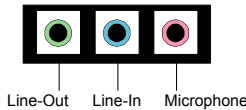

The **Line-Out** jack is for connecting to external speakers or headphones.

The **Line-In** jack is for connecting to an external audio device such as a CD player, tape player, etc....

The **Mic** jack is for connecting to a microphone.

Note: The Audio ports can be switched to Smart 5.1 6-channel audio output. You can enable the function by clicking the “Vinyl Audio” icon on your desktop after installing the audio driver.

After completing the previous settings, you need to connect your speakers to the audio jacks as shown below.

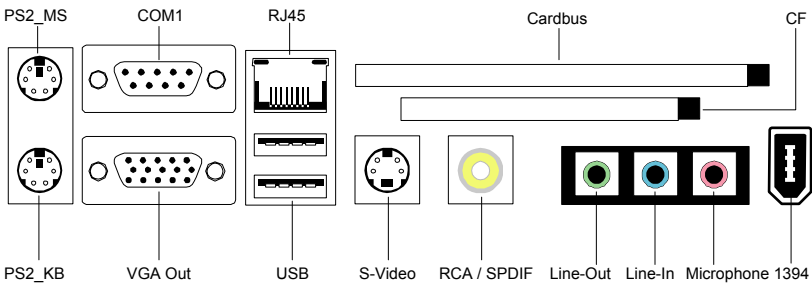

Connectors

Hard Disk Connectors: IDE1 & IDE2

The mainboard has a 32-bit Enhanced PCI IDE and Ultra DMA 66/100 controller that provides PIO mode 0-4, Bus Master, and Ultra DMA 66/100 functions. You can connect up to four hard disk drive, CD-ROM, LS-120 and other devices. These connectors utilize the provided IDE hard disk cable.

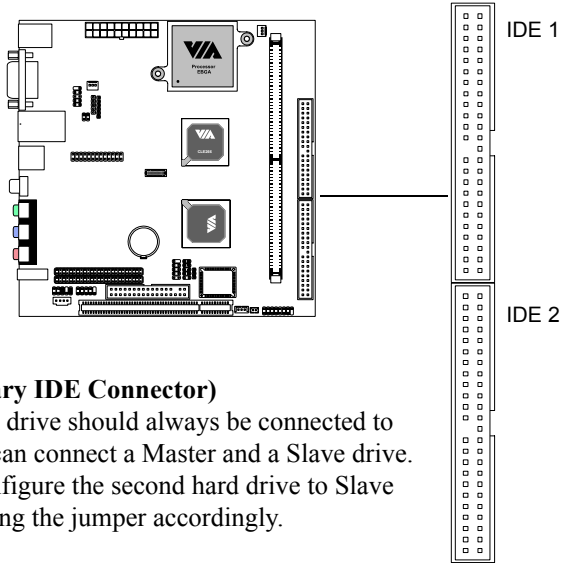

IDE1 (Primary IDE Connector)

The first hard drive should always be connected to IDE1. IDE1 can connect a Master and a Slave drive. You must configure the second hard drive to Slave mode by setting the jumper accordingly.

IDE2 (Secondary IDE Connector)

IDE2 can also connect a Master and a Slave drive.

If you install two hard disks on a single cable, you must set the jumper on the second hard disk drive to slave mode. Please refer to the hard disk documentation supplied by hard disk vendor for the jumper settings.

Case Connector: F_PANEL

The F_PANEL connector block allows you to connect to the power switch, reset switch, power LED, HDD LED, SLED and the Speaker on the case.

Pin	Signal	Pin	Signal
1	PWR LED+	2	HDD LED+
3	PWR LED-	4	HDD LED-
5	PWR LED-	6	PW_BN+
7	SPEAKER+	8	PW_BN-
9	NC	10	RESET+
11	NC	12	RESET-
13	SPEAKER-	14	SLP_LED+
15	NC	16	SLP_LED-

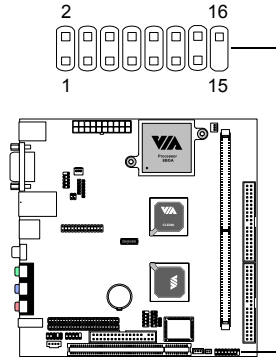

Power Switch (PW_BN)

Connect to a 2-pin push button switch. Pressing this button will turn the system power on or off.

Reset Switch (RESET)

The Reset Switch is used to reboot the system rather than turning the power ON/OFF. Avoid rebooting while the HDD is working. You can connect the Reset Switch from the system case to this pin.

Power LED (PWR LED)

The LED is lit when the system is power on. If the system is in S1 (POS - Power On Suspend) or S3 (STR - Suspend To RAM) state, the LED will blink.

HDD LED

HDD LED shows the activity of a hard disk drive. Avoid turning the power off while HDD LED is lit. Connect the HDD LED from the system case to this pin.

SLP_LED

The SLP_LED is lit when the system is in the S1 (POS - Power On Suspend) state.

Speaker

The speaker from the system case is connected to this pin

IrDA Infrared Module Connector: FIR

This connector allows you to connect an IrDA Infrared module. You must configure the setting through the BIOS setup to activate the IR function.

Pin	Signal
1	VCC
2	IRRX2
3	IRRX
4	GND
5	IRTX

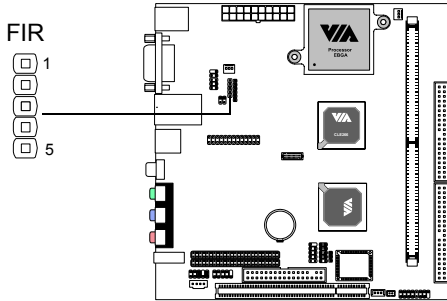

Consumer Infrared Module / PS2 Header: KBMS

When the header is not in use, please short pin 3&5, pin 4&6, pin 7&9, and pin 8&10.

Pin	Signal	Pin	Signal
1	+5V	2	GND
3	KB_CLK	4	KB_DATA
5	EXT_KBCLK	6	EXT_KBDATA
7	MS_CLK	8	MS_DATA
9	EXT_MSCLK	10	EXT_MSDATA

CIR / EXT. KBMS

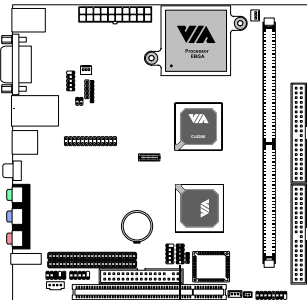
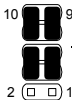

USB pin-header: USB3/4

The mainboard provides 1 USB pin-header connector, allowing up to 2 additional USB ports. Please plug the USB 2-port module onto this pin-header.

Pin	Signal	Pin	Signal
1	VCC	2	VCC
3	USB2 -	4	USB 3 -
5	USB2 +	6	USB 3 +
7	GND	8	GND
9	NC	10	GND

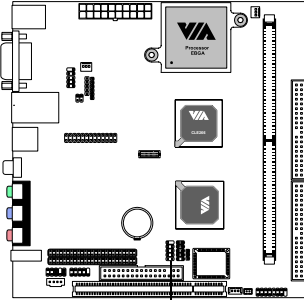
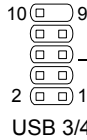

Wake-on LAN: WOL

This connector allows you to connect a network card with the Wake-On LAN function. The connector will power up the system when a signal is received through the network card. Please note that the function of ACPI WOL may be disabled when users unplug the power cord or turn off the power button manually.

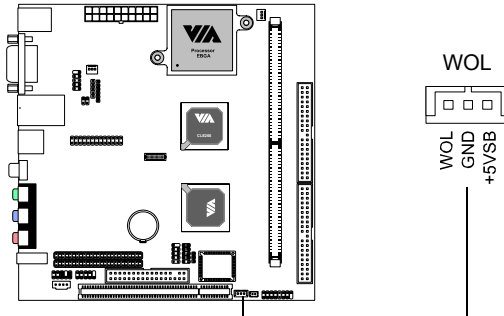

COM2: The Second Serial Port

COM2 is a pin header for second serial port.

Pin	Signal	Description
1	DCD	Data Carry Detect
2	SIN	Serial In or Receive Data
3	SOUT	Serial Out or Transmit Data
4	DTR	Data Terminal Ready
5	GND	Ground
6	DSR	Data Set Ready
7	RTS	Request To Send
8	CTS	Clear To Send
9	RI	Ring Indicate

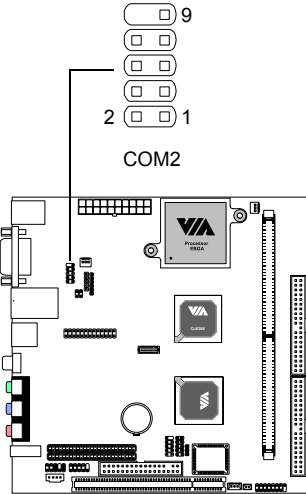

Floppy Disk Drive Connector: FDD

The floppy disk drive connector supports 360K, 720K, 1.2M, 1.44M, and 2.88M floppy disk types.

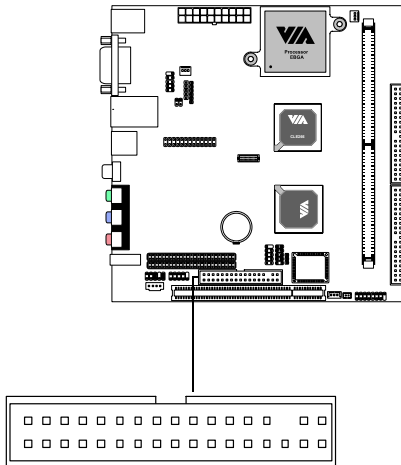

CD Audio Connector: CD_IN

This connector is for the CD-ROM audio connector.

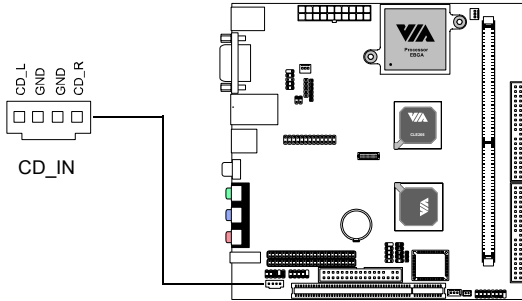

Front Audio Panel: F_AUDIO

This connector allows you to connect a front audio panel to the mainboard. Only the line-out and microphone functions are available for use on the front panel. To connect the front audio cable, first remove the two red plastic jumpers.

Pin	Signal	Pin	Signal
1	FRN_MIC	2	AGND
3	AUD_MIC_BIAS	4	+5V
5	LINE_OUT_R	6	NEXT_R
7	NC	8	Blank
9	LINE_OUT_L	10	NEXT_L

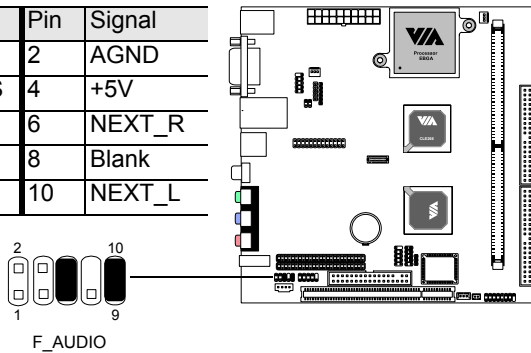

SMBus Connector: SMBus

This is for connecting a SMBus device.

Pin	Signal
1	+3.3V
2	+3.3V
3	EL-ON
4	SMBCK
5	SMBDT
6	GND

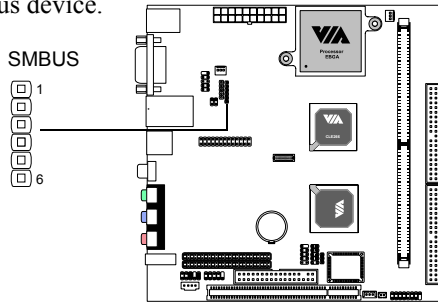

LPT Pin Header: LPT

The mainboard provides a pin header to attach a parallel port.

Pin	Signal	Pin	Signal
1	STROBE	2	AUTO FEED#
3	DATA0	4	ERR#
5	DATA1	6	INIT#
7	DATA2	8	SLIN#
9	DATA3	10	GND
11	DATA4	12	GND
13	DATA5	14	GND
15	DATA6	16	GND
17	DATA7	18	GND
19	ACK#	20	GND
21	BUSY	22	GND
23	PE	24	GND
25	SELECT	26	NC

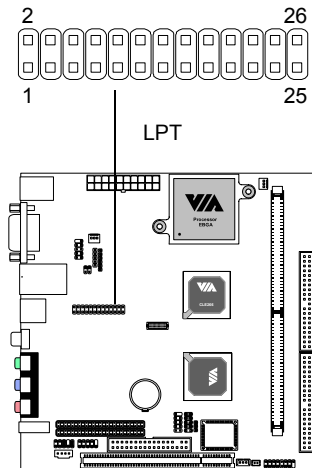

1394 Port Connector: 1394_2

The mainboard provides a connector to attach an additional 1394 port.

Pin	Signal	Pin	Signal
1	TPA0+	2	TPA0-
3	GND	4	GND
5	TPB0+	6	TPB0-
7	1394_VDD	8	1394_VDD
9	GND	10	

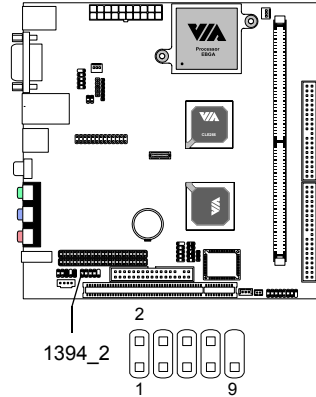

LVDS Connector (Optional)

This connector allows you to connect to a LVDS module.

The LVDS connector may not be available on your mainboard. This is an option that is added during the manufacturing process. If you would like a mainboard with the LVDS connector, please contact your vendor or sales contact for more information.

Pin	Signal	Pin	Signal
1	GFPDE	2	GFPD3
3	GFPD0	4	GFPD4
5	GFPD1	6	GFPD5
7	GFPD2	8	GFPCLK
9	GFPHS	10	GFPD6
11	GFPVS	12	GFPD7
13	GFPD11	14	GFPD8
15	GFPD12	16	GFPD9
17	ENPVDD	18	GFPD10
19	ENPVEE	20	GFPD13
21	FPBKLP	22	GFPD14
23	PWRGD_SB	24	GFPD15
25	SPCLK2	26	GFPD16
27	SPD2	28	GFPD17
29	GND	30	GFPD18
31	GND	32	GFPD19
33	3.3V	34	GFPD20
35	GND	36	GFPD21
37	5V	38	GFPD22
39	5V	40	GFPD23

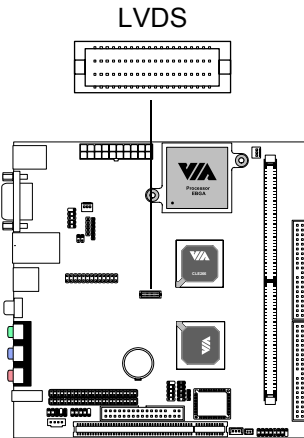

Jumpers

The mainboard provides jumpers for setting the mainboard's functions. This section will explain how to change settings for your mainboard's functions through the use of the jumpers.

Clear CMOS: CLEAR_CMOS

The onboard CMOS RAM stores system configuration data and has an onboard battery power supply. The long-life battery has a lifetime of at least 5 years. If you want to clear the system configuration data from the CMOS RAM, use the CLEAR_CMOS (Clear CMOS jumper). You can clear the CMOS by shorting pins 1 and 2 while the system is off. Then return it to the 2-3 pin position. Shorting the jumper while the system is on will damage the mainboard. The default position of the jumper is on pins 2 and 3.

Setting	1	2	3
Keep	OFF	ON	ON
Clear	ON	ON	OFF

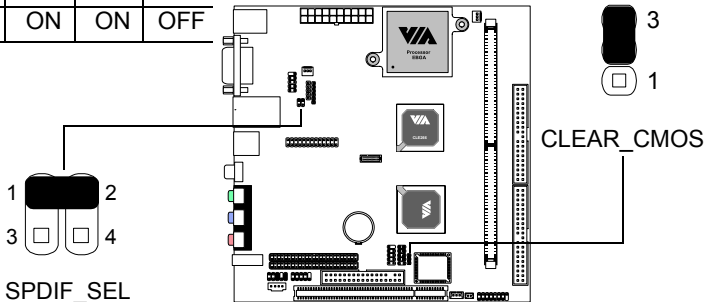

RCA Video or S/PDIF Select: SPDIF_SEL

Users can select either RCA Video or S/PDIF as the enabled function on the dual-purpose port. Please note that text may not be clear due to the lower resolution in TV sets. If the text is not legible, try enlarging the text in the OS control panels. If your TV screen flickers, set the refresh rate to 60 Hz or less.

Setting	1	2	3	4
RCA	ON	ON	OFF	OFF
SPDIF	OFF	OFF	ON	ON

Slots

Peripheral Component Interconnect: PCI

The PCI slot allows you to insert PCI expansion cards. When adding or removing expansion cards, make sure that you unplug the power supply first. Meanwhile, read the documentation for the expansion card to make any necessary hardware or software settings for the expansion card, such as jumpers, switches or BIOS configuration.

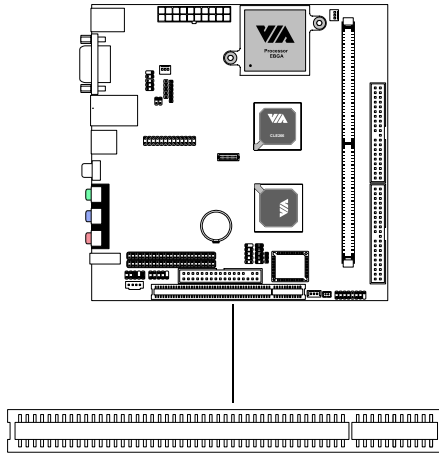

PCI Interrupt Request Routing

The IRQ, abbreviation of interrupt request line and pronounced I-R-Q, are hardware lines over which devices can send interrupt signals to the microprocessor. The “PCI & LAN” IRQ pins are typically connected to the PCI bus INT A# ~ INT D# pins as follows:

	Order 1	Order 2	Order 3	Order 4
PCI Slot	INT B#	INT C#	INT D#	INT A#

Chapter 3

BIOS Setup

This chapter gives you detailed explanation of each BIOS setup functions.

This chapter includes the following sections:

Entering Setup	3-2
Control Keys	3-2
Gettings Help	3-3
The Main Menu	3-4
Standard CMOS Features	3-6
Advanced BIOS Features	3-8
Advanced Chipset Features	3-12
Integrated Peripherals	3-14
Power Management Setup	3-18
PNP / PCI Configurations	3-23
PC Health Status	3-26
Frequency / Voltage Control	3-27
Load Fail-Safe Defaults	3-30
Load Optimized Defaults	3-31
Set Supervisor / User Password	3-32
Save & Exit Setup	3-34
Exit Without Saving	3-35

Entering Setup

Power on the computer and press **Delete** straight away to enter the BIOS setup menu. If you missed the BIOS setup entry point, you may restart the system and try again.

Control Keys

Keys	Description
Up Arrow	Move to the previous item
Down Arrow	Move to the next item
Left Arrow	Move to the item in the left side
Right Arrow	Move to the item in the right side
Enter	Select the item
Escape	Jumps to the Exit menu or returns to the main menu from a submenu
Page Up / +	Increase the numeric value or make changes
Page Down / -	Decrease the numeric value or make changes
F1	General help, only for Status Page Setup Menu and Option Page Setup Menu
F5	Restore the previous CMOS value from CMOS, only for Option Page Setup Menu
F6	Load the default CMOS value from Fail-Safe default table, only for Option Page Setup Menu
F7	Load Optimized defaults
F9	Jumps to the Main Menu
F10	Save all the CMOS changes and exit

Getting Help

Main Menu

The main menu displays all BIOS setup categories. Use the control keys **Up/Down Arrow Keys** to select any item/sub-menu. Description of the selected/highlighted category is displayed at the bottom of the screen.

Sub-Menu

If you find a right pointer symbol (as shown in the right view) appears on the left of certain fields, this means a sub-menu is available. The sub-menu contains additional options. You can use control keys **Up/Down Arrow Keys** to highlight the field and press **Enter** to enter the sub-menu. To return from the sub-menu press **Esc**.

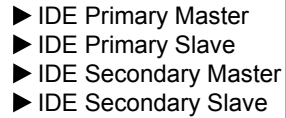
- 
- ▶ IDE Primary Master
 - ▶ IDE Primary Slave
 - ▶ IDE Secondary Master
 - ▶ IDE Secondary Slave

General Help: F1

The BIOS setup program provides a General Help screen. You can call up this screen from any menu/sub-menu by pressing **F1**. The help screen displays the keys for use and navigate the BIOS setup. Press **Esc** to exit the help screen.

The Main Menu

The Main Menu contains twelve setup functions and two exit choices. Use arrow keys to select the items and press **Enter** to accept or enter the sub-menu.

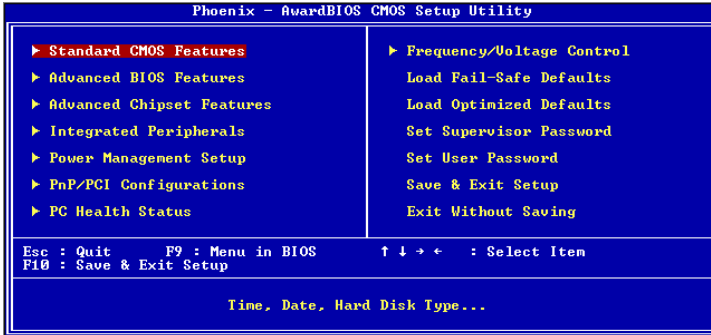

Standard CMOS Features

Use this menu to set basic system configurations.

Advanced BIOS Features

Use this menu to set the advanced features available on your system.

Advanced Chipset Features

Use this menu to set chipset specific features and optimize system performance.

Integrated Peripherals

Use this menu to set onboard peripherals features.

Power Management Setup

Use this menu to set onboard power management functions.

PnP/PCI Configurations

Use this menu to set the PnP and PCI configurations.

PC Health Status

This menu shows the PC health status.

Frequency/Voltage Control

Use this menu to set the system frequency and voltage control.

Load Fail-Safe Defaults

Use this menu option to load the BIOS default settings for minimal and stable system operations.

Load Optimized Defaults

Use this menu option to load BIOS default settings for optimal and high performance system operations.

Set Supervisor Password

Use this menu option to set the BIOS supervisor password.

Set User Password

Use this menu option to set the BIOS user password.

Save & Exit Setup

Save BIOS setting changes and exit setup.

Exit Without Saving

Abandon all BIOS setting changes and exit setup.

Standard CMOS Features

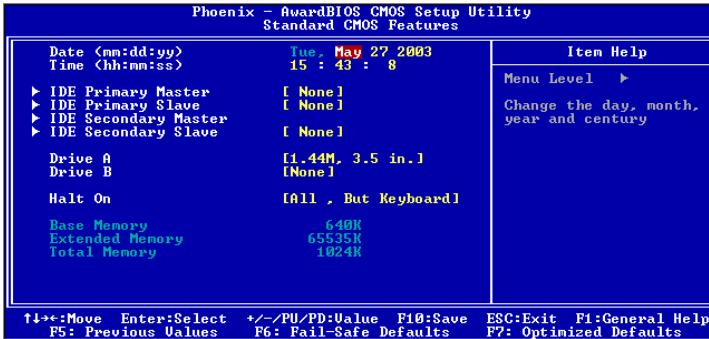

Date

The date format is <Day><Month><Date><Year>.

Day - day of the week, for example Friday. Read-only.

Month - the month from Jan to Dec.

Date - the date from 1 to 31.

Year - the year, range from 1999 to 2098.

Time

The time format is <Hour><Minute><Second>.

Drive A/B

Set the type of floppy drive installed. Settings: *None*, *360K (5.25 in.)*, *1.2M (5.25 in.)*, *720K (3.5 in.)*, *1.44M (3.5 in.)*, *2.88M (3.5 in.)*

Halt On

Determine the system behaviour if an error is detected at boot. Settings are:

- All Errors* System halts when any error is detected.
- No Errors* System does not halt for any error.
- All, But Keyboard* System halts for all non-key errors.
- All, But Diskette* System halts for all non-disk errors.
- All, But Disk/Key* System halts for all non-key and non-disk errors.

IDE Primary Master/Slave, Secondary Master/Slave

Press **Enter** to enter the sub-menu and the following screen appears:

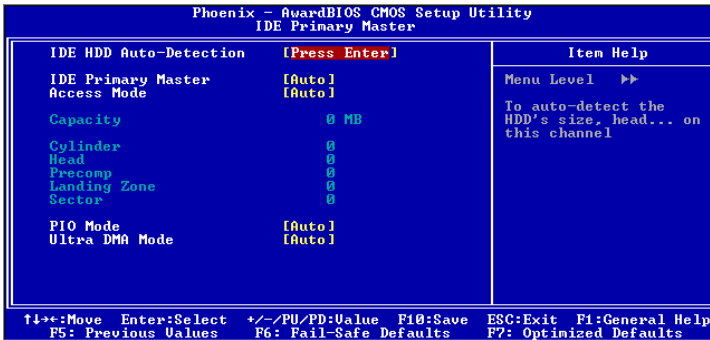

The specifications of your drive must match with the drive table. The hard disk will not work properly if you enter improper information for this category. Select *Auto* whenever possible. If you select *Manual*, make sure the information provided is from your hard disk vendor or system manufacturer.

<i>IDE <Primary Master></i>	The name of this menu item will match the name of the menu. The settings are <i>None</i> , <i>Auto</i> , <i>Manual</i> .
<i>Access Mode</i>	The settings are <i>CHS</i> , <i>LBA</i> , <i>Large</i> , <i>Auto</i> .
<i>Capacity</i>	The formatted size of the storage device.
<i>Cylinder</i>	Number of cylinders.
<i>Head</i>	Number of heads.
<i>Precomp</i>	Write precompensation.
<i>Landing Zone</i>	Cylinder location of the landing zone.
<i>Sector</i>	Number of sectors.
<i>PIO Mode</i>	The settings are <i>Mode 0/1/2/3/4</i> , <i>Auto</i> .
<i>Ultra DMA Mode</i>	The settings are <i>Disabled</i> and <i>Auto</i> .

Advanced BIOS Features

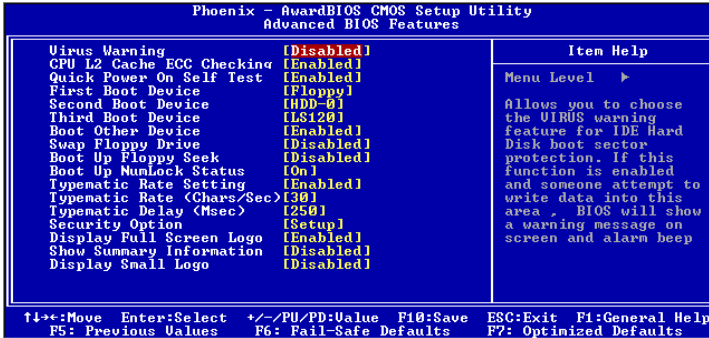

Virus Warning

Set the Virus Warning feature for IDE Hard Disk boot sector protection. If the function is enabled, any attempt to write data into this area will cause a beep and warning message display on screen. Settings: *Disabled* and *Enabled*

CPU L2 Cache ECC Checking

Set the ECC (Error-Correcting Code) feature for Level 2 cache. Facilitates error detection/correction when data passes through Level 2 cache. Settings: *Enabled* and *Disabled*

Quick Power On Self Test

Shorten Power On Self Test (POST) cycle and enable shorter bootup time. Allow BIOS to skip some check items during POST. Settings: *Enabled* and *Disabled*

First/Second/Third Boot Device

Set the boot device sequence as BIOS attempts to load the disk operating system. The settings are:

<i>Floppy</i>	The system will boot from floppy drive.
<i>LS120</i>	The system will boot from LS-120 drive.
<i>HDD-0</i>	The system will boot from first HDD.
<i>SCSI</i>	The system will boot from SCSI.
<i>CD-ROM</i>	The system will boot from CD-ROM.
<i>HDD-1</i>	The system will boot from second HDD.
<i>HDD-2</i>	The system will boot from third HDD.
<i>HDD-3</i>	The system will boot from fourth HDD.
<i>ZIP100</i>	The system will boot from ATAPI ZIP drive.
<i>USB-FDD</i>	The system will boot from USB floppy drive.
<i>USB-ZIP</i>	The system will boot from USB ZIP drive.
<i>USB-CDROM</i>	The system will boot from USB CDR0M.
<i>USB-HDD</i>	The system will boot from USB HDD.
<i>LAN</i>	The system will boot from network drive.
<i>Disabled</i>	Disable this sequence.

Boot Other Device

Enable the system to boot from other devices if the system fails to boot from the First/Second/Third boot device. Settings: *Enabled* and *Disabled*

Swap Floppy Drive

If the system has two floppy drives, choose *Enabled* to assign physical drive B to logical drive A and vice versa. Settings: *Enabled* and *Disabled*

Boot Up Floppy Seek

Set floppy seek during POST, BIOS will determine whether the floppy is 40 or 80 tracks. Settings: *Enabled* and *Disabled*

Boot Up NumLock Status

Set the NumLock status when the system is powered on. *On* will turn key pad into number keys, and *Off* will turn key pad into arrow keys. Settings: *On* and *Off*

Typematic Rate Setting

When *Disabled*, the following two items (Typematic Rate and Typematic Delay) are irrelevant. Keystrokes repeat at a rate determined by the keyboard controller in your system. When *Enabled*, you can select a typematic rate and typematic delay. Settings: *Enabled* and *Disabled*

Typematic Rate (Chars/Sec)

When Typematic Rate Setting is enabled, this item allows you to set the rate (characters/second) at which the keys are accelerated. Settings: *6, 8, 10, 12, 15, 20, 24* and *30*

Typematic Delay (Msec)

When Typematic Rate Setting is enabled, this item allows you to select the delay between when the key was first pressed and when the acceleration begins. Settings: *250, 500, 750* and *1000*

Security Option

If you have set a password, select whether the password is required every time the System boots, or only when you enter Setup. Settings are described below:

- | | |
|---------------|--|
| <i>Setup</i> | The password prompt appears only when end users try to run Setup. |
| <i>System</i> | A password prompt appears every time when the computer is powered on or when end users try to run Setup. |

Display Full Screen Logo

Show full screen logo during BIOS bootup process. Settings: *Enabled* and *Disabled*

Show Summary Information

Settings: *Enabled* and *Disabled*

Display Small Logo

Show small energy star logo during BIOS bootup process. Settings: *Enabled* and *Disabled*

Advanced Chipset Features

The Advanced Chipset Features menu is used for optimizing the chipset functions.

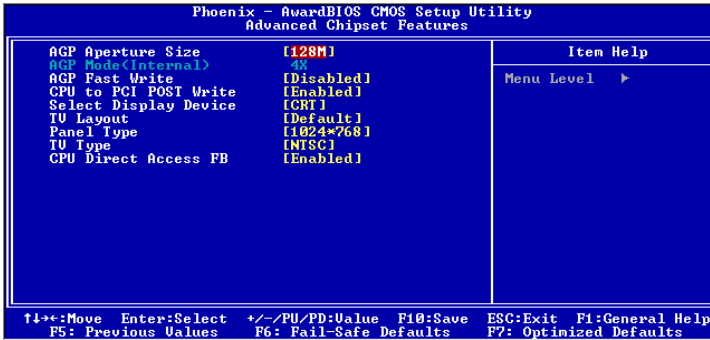

WARNING: Do not change these settings unless you are familiar with the chipset.

AGP Aperture Size

This setting controls how much memory space can be allocated to AGP for video purposes. The aperture is a portion of the PCI memory address range dedicated to graphics memory address space. Host cycles that hit the aperture range are forwarded to the AGP without any translation. Settings: 4MB, 8MB, 16MB, 32MB, 64MB, 128MB, and 256MB

AGP Mode (Internal)

This mainboard supports the AGP 4x interface. When the AGP 4x video card is used, it can transfer video data at 1066MB/s. AGP 4x is backward-compatible, leave the default 4x mode on if unsure. When set to 1x mode, the maximum transfer rate is at 266MB/s, and 2x mode transfers data at 533MB/s. AGP8x mode can be detected automatically once you plug in the AGP8x card. Settings: 4X, 2X and 1X

AGP Fast Write

When *Enabled*, the speed of the memory write operations will increase.

Settings: *Enabled* and *Disabled*

CPU to PCI POST Write

When *Enabled*, CPU can write up to four words of data to the PCI write buffer before CPU must wait for PCI bus cycle to finish. If *Disabled*, CPU must wait after each write cycle until PCI bus signals that it is ready to receive more data. Settings: *Enabled* and *Disabled*

Select Display Device

This setting refers to the type of display being used with the system.

Settings: *CRT*, *TV*, *CRT + TV*, *LCD* and *CRT + LCD*

TV Layout

Settings: *Default*, *COMP. + S-Video*, *S-Video + S-Video*, *COMP. + RGB*, *COMP. + YCbCr*, *COMP. + SDTV-RGB*, *COMP. + SDTV-YPbPr*, *Composite*, *S-Video*, *RGB*, *YCbCr*, *SDTV-RGB*, *SDTV-YPbPr*, *S-Video + RGB* and *S-Video + YCbCr*

Panel Type

This setting refers to the native resolution of the display being used with the system. Settings: *1600x1200*, *1400.1050*, *1280,1024*, *1280x768*, *1024x768*, *800x600* and *640x480*

TV Type

Settings: *NTSC* and *PAL*

CPU Direct Access FB

Settings: *Enabled* and *Disabled*

Integrated Peripherals

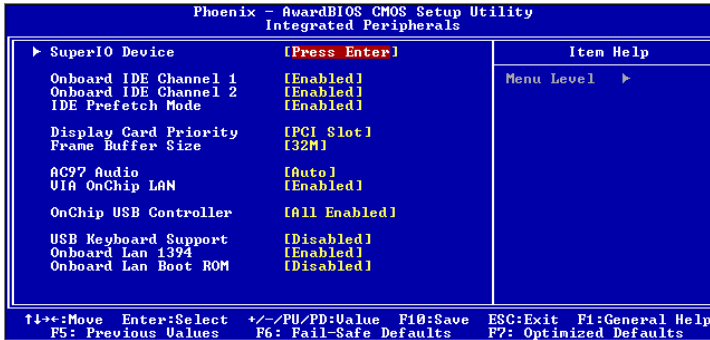

Onboard IDE Channel 1/2

The integrated peripheral controller contains an IDE interface with support for two IDE channels. Choose *Enabled* to activate each channel separately. Settings: *Enabled* and *Disabled*

IDE Prefetch Mode

This allows your hard disk controller to use the fast block mode to transfer data to and from the hard disk drive. Block mode is also called block transfer, multiple commands or multiple sector read/write. *Enabled* enables IDE controller to use block mode; *Disabled* allows the controller to use standard mode. Settings: *Enabled* and *Disabled*

Display Card Priority

This setting specifies which VGA card is your primary graphics adapter. Settings: *PCI Slot* and *AGP*

Frame Buffer Size

This setting instructs the BIOS to reserved the specified amount of memory for the internal video controller. Settings: *16M*, *32M*, *64M*

AC97 Audio

Auto allows the mainboard to detect whether an audio device is used. If the device is detected, the onboard VIA AC'97 (Audio Codec'97) controller will be enabled; if not, it is disabled. Disable the controller if you want to use other controller cards to connect to an audio device. Settings: *Auto* and *Disabled*

VIA OnChip LAN

This setting allows you to make VIA OnChip LAN enabled or disabled. Settings: *Enabled* and *Disabled*

OnChip USB Controller

Settings: *All Enabled* and *All Disabled*

USB Keyboard Support

Enable USB Keyboard Support for DOS and Windows. Settings: *Enabled* and *Disabled*

Onboard 1394

Enables the onboard 1394 controller. Settings: *Enabled* and *Disabled*

Onboard Lan Boot ROM

Enable Onboard Lan Boot ROM for DOS and Windows. Settings: *Enabled* and *Disabled*

SuperIO Device

Press **Enter** to enter the sub-menu and the following screen appears:

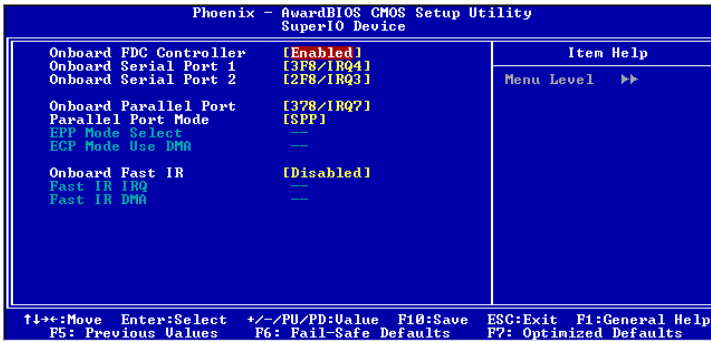

Onboard FDC Controller

Enable the onboard floppy controller. Select *Enabled* when you have installed a floppy disk drive. Settings: *Enabled, Disabled*

Onboard Serial Port 1/2

Set the base I/O port address and IRQ for the onboard serial port A/serial port B. Selecting *Auto* allows BIOS to automatically determine the correct base I/O port address. Settings:

Port	Settings					
1	Disabled	3F8/IRQ4	2F8/IRQ3	3E8/IRQ4	2E8/IRQ3	Auto
2	Disabled	3F8/IRQ4	2F8/IRQ3	3E8/IRQ4	2E8/IRQ3	Auto

Onboard Parallel Port

This specifies the I/O port address and IRQ of the onboard parallel port. Settings: *Disabled, 378/IRQ7, 278/IRQ5, 3BC/IRQ7*

Parallel Port Mode

Set the parallel port mode. To operate the onboard parallel port as Standard Parallel Port, choose *SPP*. To operate the onboard parallel port in the EPP mode, choose *EPP*. By choosing *ECP*, the onboard parallel port will operate in ECP mode. Choosing *ECP + EPP* will allow the onboard parallel port to support both the ECP and EPP modes simultaneously. Settings: *SPP, EPP, ECP, ECP + EPP*

EPP Mode Select

EPP (Enhanced Parallel Port) comes in two modes: 1.9 and 1.7. EPP 1.9 is the newer version of the protocol and is backwards compatible with most EPP devices. If your EPP device does not work with the EPP 1.9 setting, try changing the setting to EPP 1.7.

Settings: *EPP 1.9, EPP 1.7*

ECP Mode Use DMA

ECP (Extended Capabilities Port) has two DMA channels that it can use. The default channel is 3. However, some expansion cards may use channel 3 as well. To solve this conflict, change the ECP channel to 1. Select a DMA channel for the port. Settings: *1, 3*

Onboard Fast IR

Enables or disables the infrared port. Settings: *Enabled* and *Disabled*

Fast IR IRQ

Set this field to reserve an IRQ for the Fast IR port. This field is only available if Onboard Fast IR is enabled. Settings: *3, 4, 5, 11*

Fast IR DMA

Set this field to choose the DMA channel. This field is only available if Onboard Fast IR is enabled. Settings: *6, 5*

Power Management Setup

The Power Management Setup menu configures the system to most effectively save energy while operating in a manner consistent with your own style of computer use.

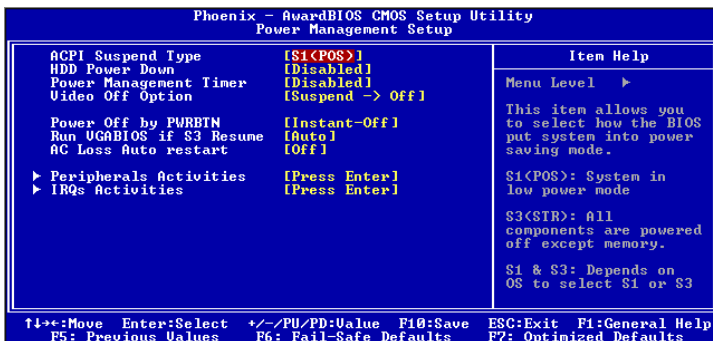

ACPI Suspend Type

Set the power saving mode for ACPI function. Settings are:

- S1(POS)** S1/Power On Suspend (POS) is a low power state. In this state, no system context (CPU or chipset) is lost and hardware maintains all system context.
- S3(STR)** S3/Suspend To RAM (STR) is a power-down state. In this state, power is supplied only to essential components such as main memory and wakeup-capable devices. The system context is saved to main memory, and context is restored from the memory when a “wakeup” event occurs.
- S1 & S3** Depends on OS to select S1 or S3.

HDD Power Down

Set the time to power down HDD after hard disk inactivity. Settings: *Disabled* and *1~15* (minutes)

Power Management Timer

Set the idle time before system enters power saving mode. ACPI OS such as Windows XP will override this option. Settings: *Disabled* and *1/2/4/6/8/10/20/30/40* (minutes) and *1* (hour)

Video Off Option

Select whether or not to turn off the screen when system enters power saving mode, ACPI OS such as Windows XP will override this option. Settings are:

- | | |
|--------------------------|--|
| <i>Always On</i> | The screen is always on even when system enters power saving mode. |
| <i>Suspend -> Off</i> | The screen is turned off when system enters power saving mode. |

Power Off by PWRBTN

This field configures the power button function. Settings are:

- | | |
|--------------------|---|
| <i>Delay 4 Sec</i> | The system is turned off if power button is pressed for more than four seconds. |
| <i>Instant-Off</i> | The power button functions as a normal power-on/-off button. |

Run VGABIOS if S3 Resume

Select whether to run VGA BIOS if resumed from S3 state. This is only necessary for older VGA drivers, select *Auto* if in doubt. Settings: *Auto*, *Yes* and *No*

AC Loss Auto restart

The field defines how the system will act after an AC power loss during system operation. *Off* will keep the system in an off state until the power button is pressed. When set to *On* the system will restart when the power is back. *Former-Sts* will restore the system to its previous state. Settings: *Off*, *On*, *Former-Sts*

Peripheral Activities

Press **Enter** to enter the sub-menu and the following screen appears:

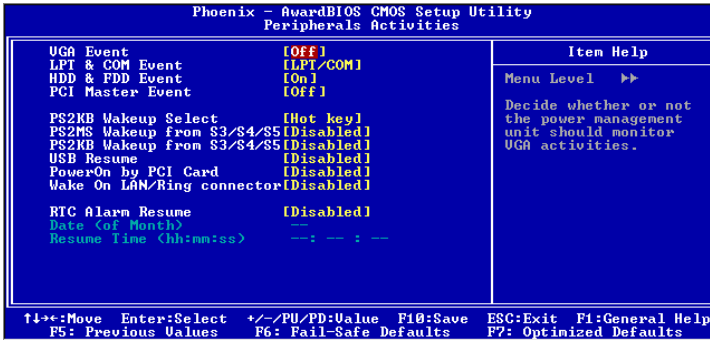

VGA Event

Decide whether or not the power management unit should monitor VGA activities. Settings: *Off* and *On*

LPT & COM Event

Decide whether or not the power management unit should monitor parallel port (LPT) and serial port (COM) activities. Settings: *None*, *LPT*, *COM* and *LPT/COM*

HDD & FDD Event

Decide whether or not the power management unit should monitor hard disks and floppy drives activities. Settings: *Off* and *On*

PCI Master Event

Decide whether or not the power management unit should monitor PCI master activities. Settings: *Off* and *On*

PS2KB Wakeup Select

When select *Password*, please press **Page Up** or **Page Down** key to change *Password*, 8 characters maximum. Please note that PS2MS Wakeup from suspend and PS2KB Wakeup from suspend will be disabled while changing the password. Settings: *Hot key* and *Password*

PS2MS Wakeup from S3/S4/S5

This setting can be used to wakeup the system from power saving mode through mouse. Settings: *Disabled* and *Enabled*

PS2KB Wakeup from S3/S4/S5

Select which Hot-Key to wake-up the system from power saving mode. Settings: *Disabled*, *Ctrl+F1*, *Ctrl+F2*, *Ctrl+F3*, *Ctrl+F4*, *Ctrl+F5*, *Ctrl+F6*, *Ctrl+F7*, *Ctrl+F8*, *Ctrl+F9*, *Ctrl+F10*, *Ctrl+F11*, *Ctrl+F12*, *Power*, *Wake* and *Any Key*

USB Resume

Decide whether or not USB devices can wake the system from suspend state. Settings: *Disabled* and *Enabled*

PowerOn by PCI Card

Decide whether or not any PCI card can power up the system or resume from suspend state. Such PCI cards include LAN, onboard USB ports, etc. Settings: *Disabled* and *Enabled*

Wake On LAN/Ring Connector

Decide whether or not any Ring-In signals from the modem can wake up the system or resume from suspend state. Settings: *Disabled* and *Enabled*

RTC Alarm Resume

The field is used to enable or disable the feature of booting up the system on a scheduled time/date. Settings: *Disabled* and *Enabled*

Date (of Month)

This field can only be set if RTC Alarm Resume is enabled. The field specifies the date for *RTC Alarm Resume*.

Resume Time (hh:mm:ss)

This field can only be set if RTC Alarm Resume is enabled. The field specifies the time for *RTC Alarm Resume*.

IRQs Activities

Press **Enter** to enter the sub-menu and the following screen appears:

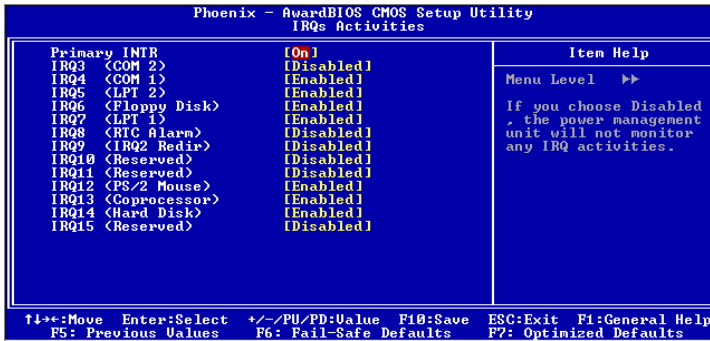

Primary INTR

Selecting *On* will cause the system to wake up from power saving modes if activity is detected from any enabled IRQ channels. Settings: *Off, On*

IRQ3~IRQ15

Enables or disables the monitoring of the specified IRQ line. If set to *Enabled*, the activity of the specified IRQ line will prevent the system from entering power saving modes or awaken it from power saving modes. These fields are only available if Primary INTR is on. Settings: *Enabled* and *Disabled*

Note: IRQ (Interrupt Request) lines are system resources allocated to I/O devices. When an I/O device needs to gain attention of the operating system, it signals this by causing an IRQ to occur. After receiving the signal, when the operating system is ready, the system will interrupt itself and perform the service required by the I/O device.

PNP/PCI Configurations

This section describes the BIOS configuration of the PCI bus system. This section covers some very technical items and it is strongly recommended that only experienced users should make any changes to the default settings.

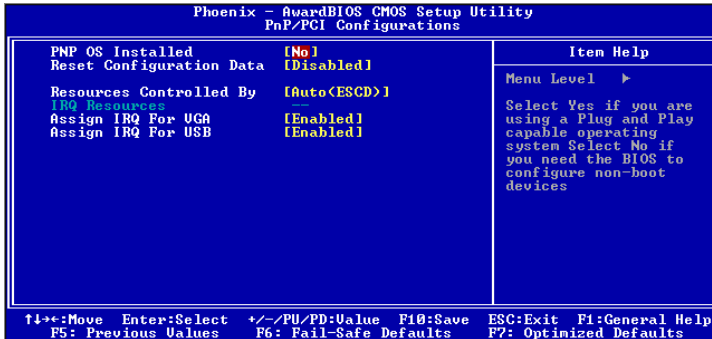

PNP OS Installed

When set to *Yes*, BIOS will only initialize the PnP cards used for booting (VGA, IDE, SCSI). The rest of the cards will be initialized by the PnP operating system like Windows® 95 or 98/98SE. When set to *No*, BIOS will initialize all the PnP cards. Set to *Yes* the operating system is Plug & Play capable. Settings: *No* and *Yes*

Reset Configuration Data

Normally, you leave this field *Disabled*. Select *Enabled* to reset Extended System Configuration Data (ESCD) when you exit Setup if you have installed a new add-on and the system reconfiguration has caused such a serious conflict that the operating system can not boot. Settings: *Enabled* and *Disabled*

Resource Controlled By

The BIOS can automatically configure all the boot and Plug and Play compatible devices. Choose *Auto(ESCD)* if unsure, the BIOS will automatically assign IRQ, DMA and memory base address fields. Settings: *Auto (ESCD)* and *Manual*

Assign IRQ For VGA/USB

Assign IRQ for VGA and USB devices. Settings: *Disabled* and *Enabled*

IRQ Resources

The items are adjustable only when *Resources Controlled By* is set to *Manual*. Press **Enter** and you will enter the sub-menu of the items.

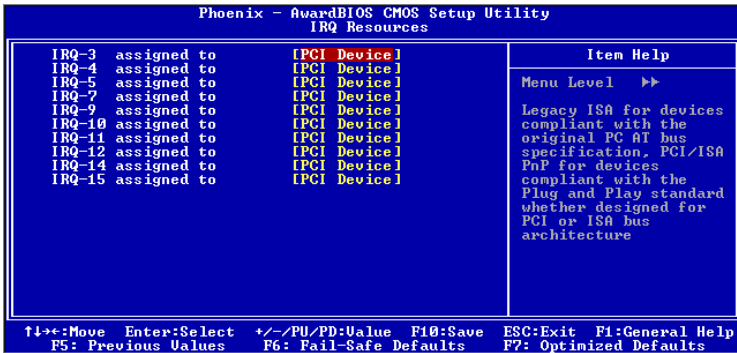

IRQ Resources list IRQ 3/4/5/7/9/10/11/12/14/15 for users to set each IRQ a type depending on the type of device using the IRQ. Settings:

- PCI Device* For Plug & Play compatible devices designed for PCI bus architecture.
- Reserved* The IRQ will be reserved for further request.

PC Health Status

This section shows the status of your CPU, fan, warning for overall system status.

Phoenix - AwardBIOS CMOS Setup Utility		Item Help
PC Health Status		Menu Level ▶
Current CPU Temp	42 C/107 F	
System Fan Speed	3622 RPM	
CPU Fan Speed	3742 RPM	
+5V	5.062 V	
CPU Ucore	1.346 V	
3.3V	3.313 V	
+12V	12.315 V	

↑↓←→:Move Enter:Select +/-/PU/PD=Value F10:Save ESC:Exit F1:General Help
F5: Previous Values F6: Fail-Safe Defaults F7: Optimized Defaults

The PC Health Status displays the current status of all of the monitored hardware devices/components such as CPU voltages, temperatures and fan speeds.

Frequency / Voltage Control

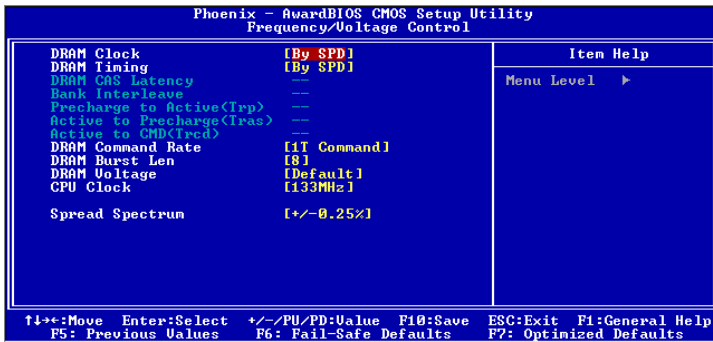

DRAM Clock

The chipset supports synchronous and asynchronous mode between host clock and DRAM clock frequency. Settings: *100 MHz*, *133 MHz*, and *By SPD*

DRAM Timing

The value in this field depends on the memory modules installed in your system. Changing the value from the factory setting is not recommended unless you install new memory that has a different performance rating than the original modules. Settings: *Manual* and *By SPD*

DRAM CAS Latency

This item adjusts the speed it takes for the memory module to complete a command. Generally, a lower setting will improve the performance of your system. However, if your system becomes less stable, you should change it to a higher setting. This field is only available when DRAM Timing is set to Manual. Settings: *2*, *2.5*

Bank Interleave

Set the interleave mode of the SDRAM interface. Interleaving allows banks of SDRAM to alternate their refresh and access cycles. One bank will undergo its refresh cycle while another is being accessed. This improves performance of the SDRAM by masking the refresh time of each bank. This field is only available when DRAM Timing is set to Manual. Settings:

Disabled, 2 Bank, 4 Bank

Precharge to Active (Trp)

This field controls the length of time it takes to precharge a row in the memory module before the row becomes active. Longer values are safer but may not offer the best performance. This field is only available when DRAM Timing is set to Manual. Settings: *2T, 3T*

Active to Precharge (Tras)

This field controls the length of time a row stays active before precharging. Longer values are safer but may not offer the best performance. This field is only available when DRAM Timing is set to Manual. Settings: *5T, 6T*

Active to CMD (Trcd)

This field is only available when DRAM Timing is set to Manual. Settings: *2T, 3T*

DRAM Command Rate

This field controls how fast the memory controller sends out commands. Lower setting equals faster command rate. Please note that some memory modules may not be able to handle lower settings. Settings: *2T Command, 1T Command*

DRAM Burst Len

This field sets the length of time for one burst of data during a read/write transaction. Longer settings equals better memory performance. Settings: *4, 8*

DRAM Voltage

This field sets the voltage for the memory module. Settings: 2.8V, 2.7V, 2.6V, *Default*

CPU Clock

This field sets the CPU clock speed.

Spread Spectrum

When the mainboard's clock generator pulses, the extreme values (spikes) of the pulses creates EMI (Electromagnetic Interference). The Spread Spectrum function reduces the EMI generated by modulating the pulses so that the spikes of the pulses are reduced to flatter curves.

Load Fail-Safe Defaults

This option on the main menu allows users to restore all the BIOS settings to the default Fail Safe values. These values are set by the mainboard manufacturer to provide a minimal and stable system.

When you select Load-Fail Safe Defaults, a message as below appears:

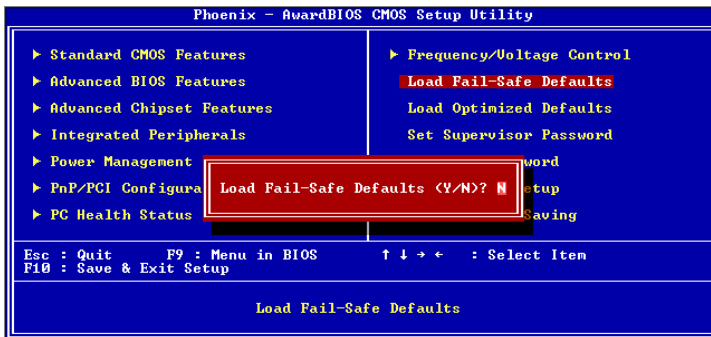

Entering Y loads the default BIOS values that provide a minimal and stable system configuration.

Load Optimized Defaults

This option on the main menu allows users to restore all the BIOS settings to the default Optimized values. The Optimized Defaults are the default values also set by the mainboard manufacturer for both optimized and stable performance of the mainboard.

When you select Load Optimized Defaults, a message as below appears:

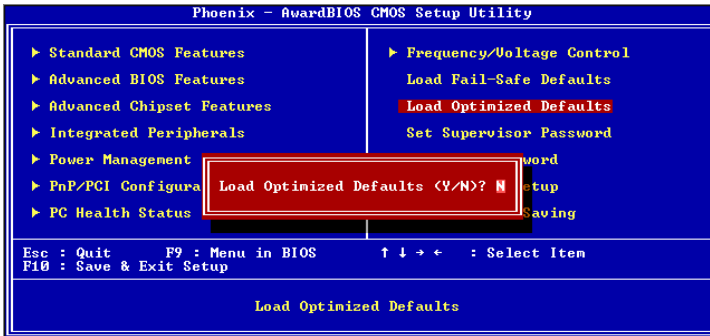

Entering Y loads the default values that are factory settings for optimal and stable system performance.

Set Supervisor / User Password

When you select this function, a message as below will appear on the screen:

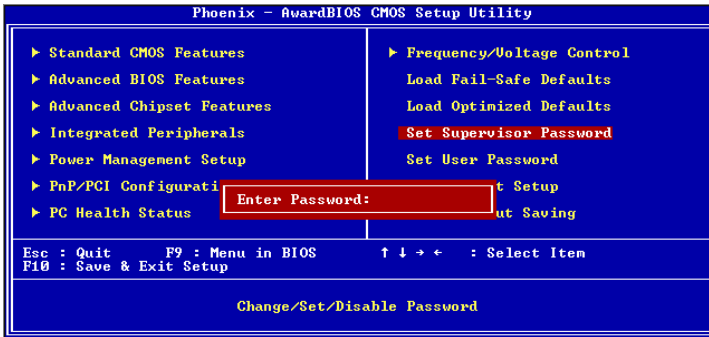

Type the password, up to eight characters in length, and press **Enter**. The password typed now will clear any previously set password from CMOS memory. You will be prompted to confirm the password. Re-type the password and press **Enter**. You may also press **Esc** to abort the selection and not enter a password.

To clear a set password, just press **Enter** when you are prompted to enter the password. A message will show up confirming the password will be disabled. Once the password is disabled, the system will boot and you can enter Setup without entering any password.

When a password has been set, you will be prompted to enter it every time you try to enter Setup. This prevents an unauthorized person from changing any part of your system configuration.

There are two types of passwords you can set. A Supervisor password and a User password. When a Supervisor password is used, the user can start BIOS Setup program and change the settings of the setup menus. When a User password is used, the user can start the BIOS Setup program but does not have the right to change the settings of the setup menus.

Additionally, when a password is enabled, you can also have BIOS to request a password each time the system is booted. This would prevent unauthorized use of your computer. The setting to determine when the password prompt is required is the Security Option of the Advanced BIOS Features menu. If the Security Option is set to *System*, the password is required both at boot and at entry to Setup. If set to *Setup*, password prompt only occurs when trying to enter Setup.

Save & Exit Setup

When you want to quit the Setup menu, you can select this option to save the changes and quit. A message as below will appear on the screen:

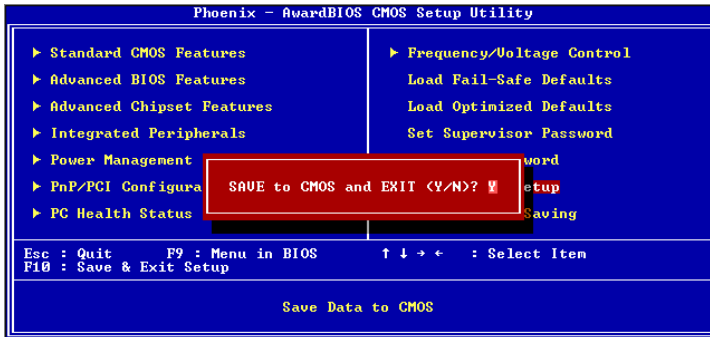

Entering *Y* will allow you to quit the Setup Utility and save the user setup changes to RTC CMOS.

Entering *N* will return to the Setup Utility.

Exit Without Saving

When you want to quit the Setup menu, you can select this option to abandon the changes. A message as below will appear on the screen:

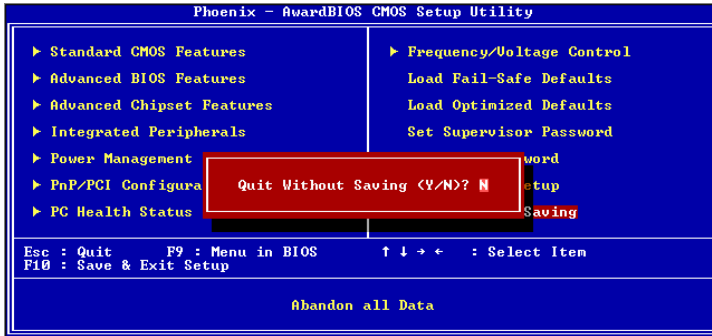

Entering *Y* will allow you to quit the Setup Utility without saving any changes to RTC CMOS.

Entering *N* will return to the Setup Utility.

Chapter

4

Driver Installation

This chapter gives you brief descriptions of each mainboard drivers and applications. You must install VIA chipset drivers first before installing other drivers such as audio or VGA drivers. The applications will only function correctly if the necessary drivers are already installed.

This chapter includes the following sections:

Driver Utilities	4-2
CD Content	4-3

Driver Utilities

Getting Started

The mainboard includes a Driver Utilities CD which contains driver utilities and software to enhance the performance of the mainboard. Please check that you have this CD in your retail box. If the CD is missing in your retail box, please contact your local dealer for the CD.

Note: The driver utilities and software are updated from time to time. Please visit our website (<http://www.viaembedded.com/>) for the latest updated mainboard driver and utilities.

Running the Driver Utilities CD

To start using the CD, just simply insert the CD into your local CD-ROM or DVD-ROM drive. The CD should run automatically when you close your CD-ROM or DVD-ROM drive. The driver utilities and software menu screen should then appear on your desktop. If the CD does not run automatically, you can run the CD manually by typing “D:\Setup.exe” at Start\Run.

(Please note that D: might not be your CD-ROM/DVD-ROM drive letter. Make sure you type the correct letter of CD-ROM/DVD-ROM drive on your system).

CD Content

The driver utilities and software in this CD are:

- **VIA 4in1 Drivers:** Contains VIA ATAPI Vendor Support Driver (enables the performance enhancing bus mastering functions on ATA-capable Hard Disk Drives and ensures IDE device compatibility), AGP VxD Driver (provides service routines to your VGA driver and interface directly to hardware, providing fast graphical access), IRQ Routing Miniport Driver (sets the system's PCI IRQ routing sequence) and VIA INF Driver (enables the VIA Power Management function).
- **VIA VGA Driver:** Enhances the onboard VIA graphic chip.
- **VIA Audio Driver:** Enhances the onboard VIA audio chip.
- **VIA LAN Driver:** Enhances the onboard VIA LAN chip.
- **VIA USB 2.0 Driver:** Enhances VIA USB 2.0 ports.
- **VIA TV-out Utility:** Enhances the TV-out by enabling display position adjustment.

