

**C6 – VARIABLE SPEED CONTROL
Rev. 6.2**

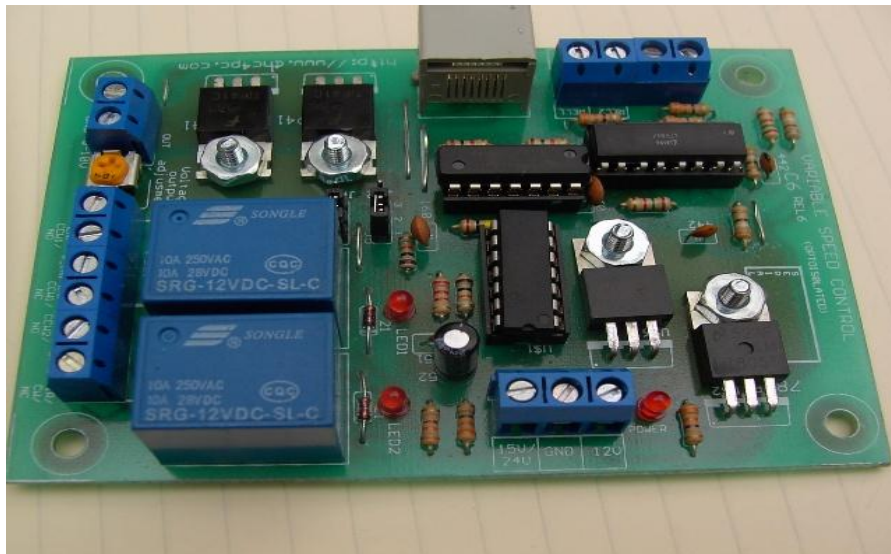

OCTOBER, 2014

USER'S MANUAL

TABLE OF CONTENTS

Page #

Contents

1.0	Overview	1
2.0	Features	1
3.0	Specifications	2
4.0	Board Description	3
5.0	Functional Block Diagrams	4
5.1	Configuring the Control Software:	4
5.2	Pinout of connector RJ45:	7
6.0	Troubleshooting	8
7.0	Dimensions	10

1.0 OVERVIEW

This card lets you control your spindle with step and direction signals, as if it was an axis motor. It convert the step signal to an analog (0-10VDC) and by using the onboard relays you can control the direction (CW/CCW) and enable the drive (On/Off).

A Variable Frequency Drive or Inverter works by modifying the frequency for AC motors. You can control most of these devices with an external analog signal (0-10VDC). That is, if there is 5VDC coming into through the control signal, the motor will run at 50% of full speed, if there was 10VDC, the motor will run at 100% of full speed. If there is no signal coming out, then the motor will stop.

This unit can also be used on many DC motor controllers by replacing the potentiometer that controls the speed.

2.0 FEATURES

- *Inputs a frequency (step) and outputs an analog 0-10VDC.*
- *Have two relays that can be used to control the direction and enable and disable the drive.*
- *Opto-isolated output signals.* The analog and CW and CCW signals are optically isolated, so this board can be used with drives that make grounds common with the mains that drive the VFD or motor.
- *All TTL +5VDC or +3.3VDC Signals.* Interface directly with parallel port interface products and other cnc4pc.com cards. 5VDC (TTL) signals are very common among automation devices.
- *Flexible design.* It works with cnc4pc's products, directly through your parallel port, or through many other parallel port control products.
- *RJ45 Connector.* This connector is for connecting the boards directly using a standard RJ45 cable, allowing can be used to carry input signal and power line.

3.0 SPECIFICATIONS

INPUT SPECIFICATIONS	
On-state voltage range	2 to 5V DC
Minimum on-state input current	16 mA
Maximum off-state voltage	0.8V
Maximum operation frequency	50KHz
Minimum on-state pulse width	3uS
Signal Type	Active High
The inputs are not buffered	

ELECTROMECHANICAL RELAYS SPECIFICATIONS	
Maximum Current (AC)	7A@240VAC; 10A@125VAC
Maximum Current (DC)	15A@24VDC; 10A@28VDC

GENERAL SPECIFICATIONS	
Dimensions	Millimeters: 105L x 75W x22D
External power	12V DC @ 200mA

Wiring:

Before connecting anything, please be sure to read your VFD's manual and make sure you understand all the safety issues.

4.0 Board Description

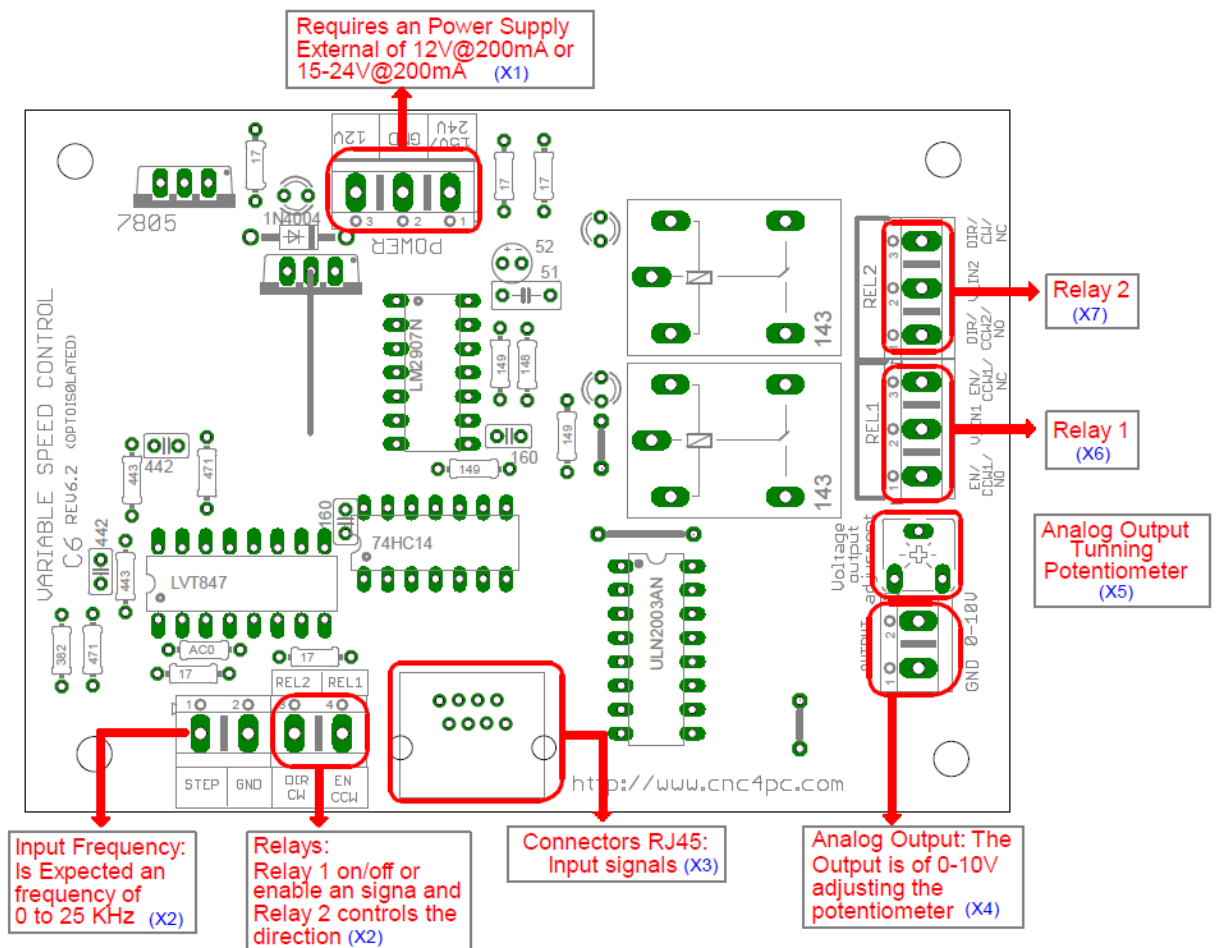

Note: A 12V or 15-24V@200mA Power Supply is required (X1).

Relay 1 and 2 can be used for CW and CCW start/stop, or one relay for start/stop and the second one for controlling direction.



WARNING: Check the polarity and voltage of the external power source and connect the 12V or 15-24V, and GND. Overvoltage or reverse polarity power applied to these terminals (X1) can cause damage to the board, and/or the power source. Must be isolated of the signals of input and is common with the analog output.

You will require a voltmeter to fine tune your system.

5.0 FUNCTIONAL BLOCK DIAGRAMS

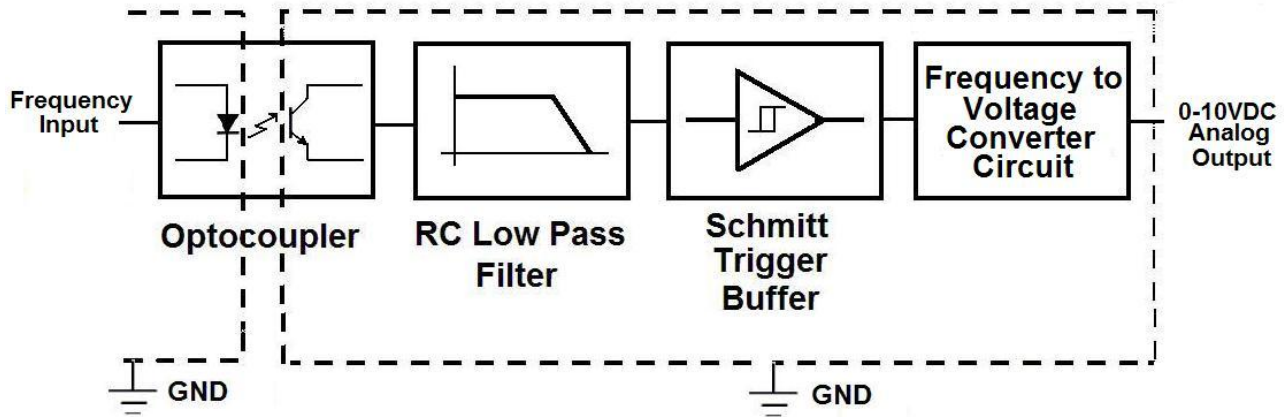

Fig. 2 C6 Analog Output Block Diagram

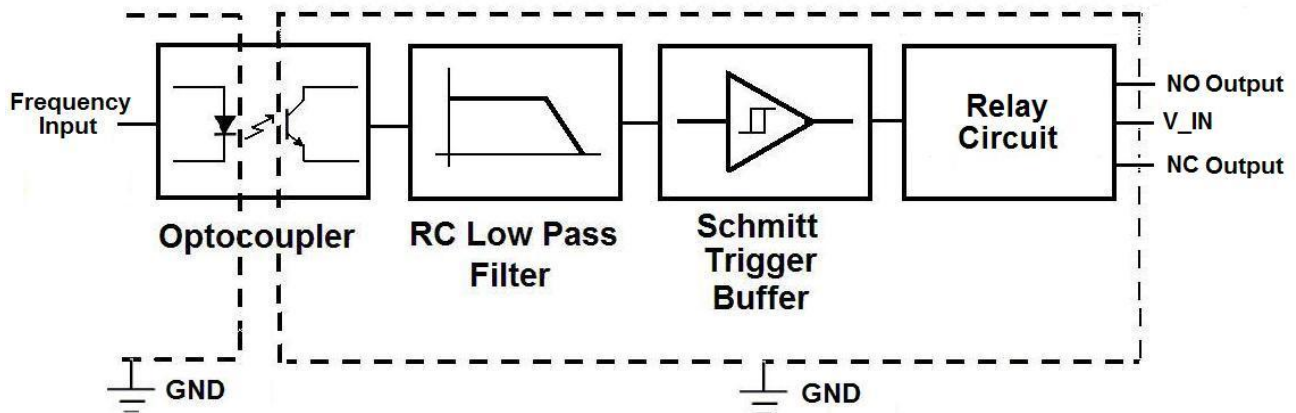

Fig. 3 C6 Relays Outputs Block Diagram

5.1 Configuring the Control Software:

It is strongly recommend you read your control software's manual. You need to configure your control software to control the spindle as if it was an angular axis. This card requires a 25 KHz input signal to deliver 10VDC. So you have to set the speed of the motor (spindle) at maximum. For acceleration values adjust them to where you feel comfortable. Keep in mind the acceleration of the motor must also be set in your VFD.

For configuring Mach follow these steps:

1. Go to Config / Ports&Pins / Motor Outputs. Enable the spindle and select the port and pins you wired for step and direction.

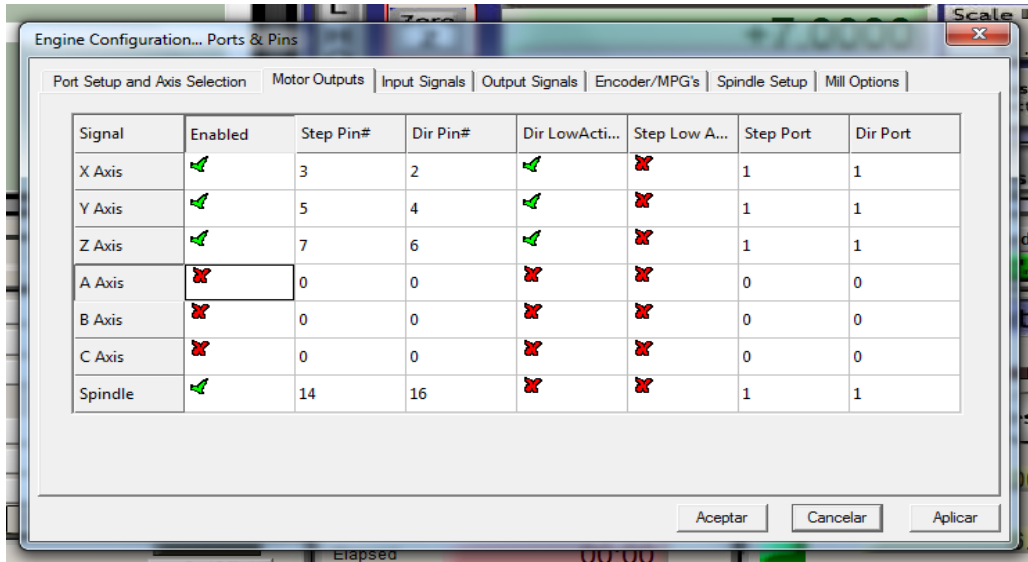

Fig. 7 Ports&Pins configuration screenshot

2. Go to Config / Ports&Pins / Spindle Setup. In the motor control box, check Use Spindle Motor Output and Step /Dir Motor. Under Pulley Ratios set the pulley ratios of the machine.

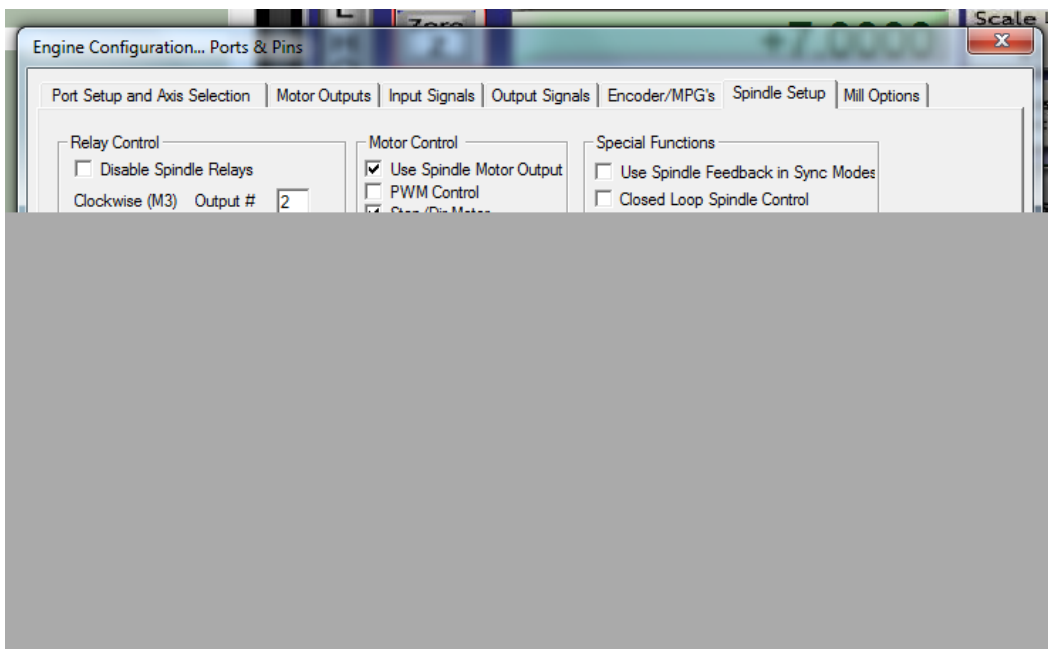
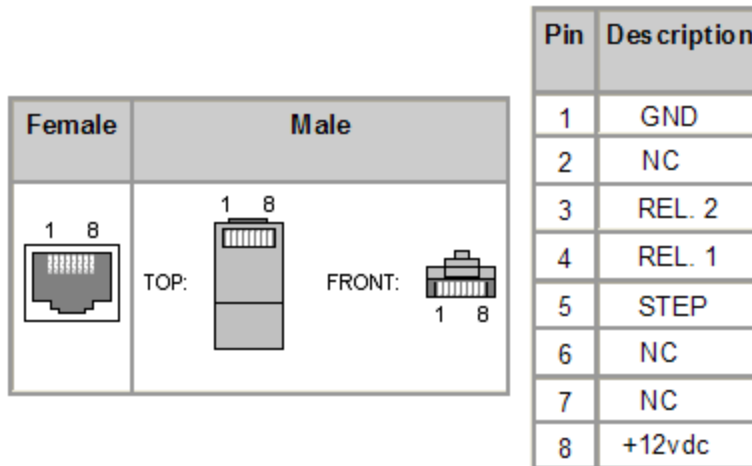

Fig. 8 Spindle Setup screenshot

Step 7 Connect the analog output ([X4](#)) and external Relay contacts ([X6](#) and/or [X7](#)).

Step 8. Turn on the external power supplies.

5.2 Pinout of connector RJ45:



Replacing a Potentiometer:

This circuit can be used to replace a potentiometer of DC motor speed control circuits. This speed controller circuits are very commonly used by SIEG, KB Electronics, and many other oriental machines. Before explaining how to do it, please first keep in mind that it can be done if the voltage that goes through the pot is +12vdc or less. This circuit cannot be used for AC currents.

In most cases the terminals that go to the potentiometer will carry these signals:

- P1 = GND
- P2 = WIPER
- P3 = REFERENCE VOLTAGE

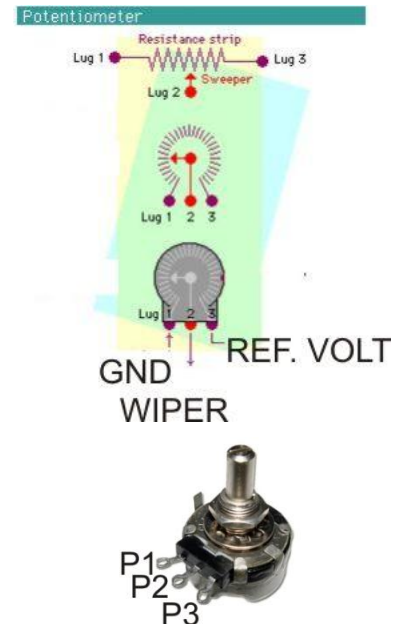

These are the steps for replacing a potentiometer:

1. Measure the voltage difference between P1 and P3. Make sure it measures under +12vdc.
2. Fine tune the analog output to the output voltage you got from step 1.
3. Connect the ground from the analog output to the ground of the potentiometer (P1).
4. Connect the analog output to the wiper connection of the potentiometer (P2).

If the reference voltage from pot is between +10 and 12vdc, you can use it to power the analog circuit (not for the C6, because the relays might draw too much power). In this case, connect P1 to the ground of the power terminal, and P3 to the +12vdc power connector.

6.0 TROUBLESHOOTING

SYMPTOM: THE BOARD DOES NOT REACT TO THE SIGNAL.

POSSIBLE CAUSE	POSSIBLE SOLUTIONS
<ul style="list-style-type: none"> - Pin conflict or mach3 configuration. It is possible that the port address used for the pin is not right, or that there is a pin conflict with the. That is that you are using that same pin twice. (it could be assigned to a different function). 	<ul style="list-style-type: none"> - Go to the device manager in windows, and check the memory address used for the parallel port you are using. Usually it will be 378 for LPT1. Check also that the port does not have a conflict. Then in mach3, go to Ports & Pins / Port Setup and Axis Selection. Check the memory address is correct. - Check that the pin you are using is not been used anywhere else in your setup. Got to motor output and output signals, and check all the entries.
<ul style="list-style-type: none"> - The signal or frequencies are not getting to the board. It could be the cable or that you are passing the signal through the same breakout board that you are enabling /disabling, so the outputs could be disabled, so they will not get to the breakout board. 	<ul style="list-style-type: none"> - Try a different cable. - Test the pins in the cable (before they reach the breakout board) with a multimeter.
<ul style="list-style-type: none"> - Problems with Mach3 Pulse Generation. Mach3 could have installation problems (you did not restart immediately after installation), or there could be something creating a 	<ul style="list-style-type: none"> - Test this in a different PC. - Follow Art's suggestions for optimizing up WinXP: http://www.machsupport.com/downloads

conflict. Some dongle devices might cause this, other software, like QuickTime or drivers for touch screen.	/XP Optimization.txt.
- The inputs signal does not have enough strength. Modern PCs come with parallel ports that have very low amperage signals; the pulse stream has to be able to provide at least 16mA signals.	- Use a breakout board to buffer and boost the signals.

SYMPTOM: THE ANALOG OUTPUT DOES NOT REACH THE 10VDC.

POSSIBLE CAUSE	POSSIBLE SOLUTIONS
- Insufficient pulse width. It is possible that the signal pulse width is not enough to activate the opt couplers.	- In Mach X, go to Config / Motor Tuning / Spindle. Under Step Pulse length increase this value, use a number from 3 to 5, but start with 3.
- The signal is set active low or the breakout board could be inverting the signals.	- In Mach X, go to Config / Ports&Pins / Motor Outputs. Change the active low status of the pin used for step.

7.0 Dimensions

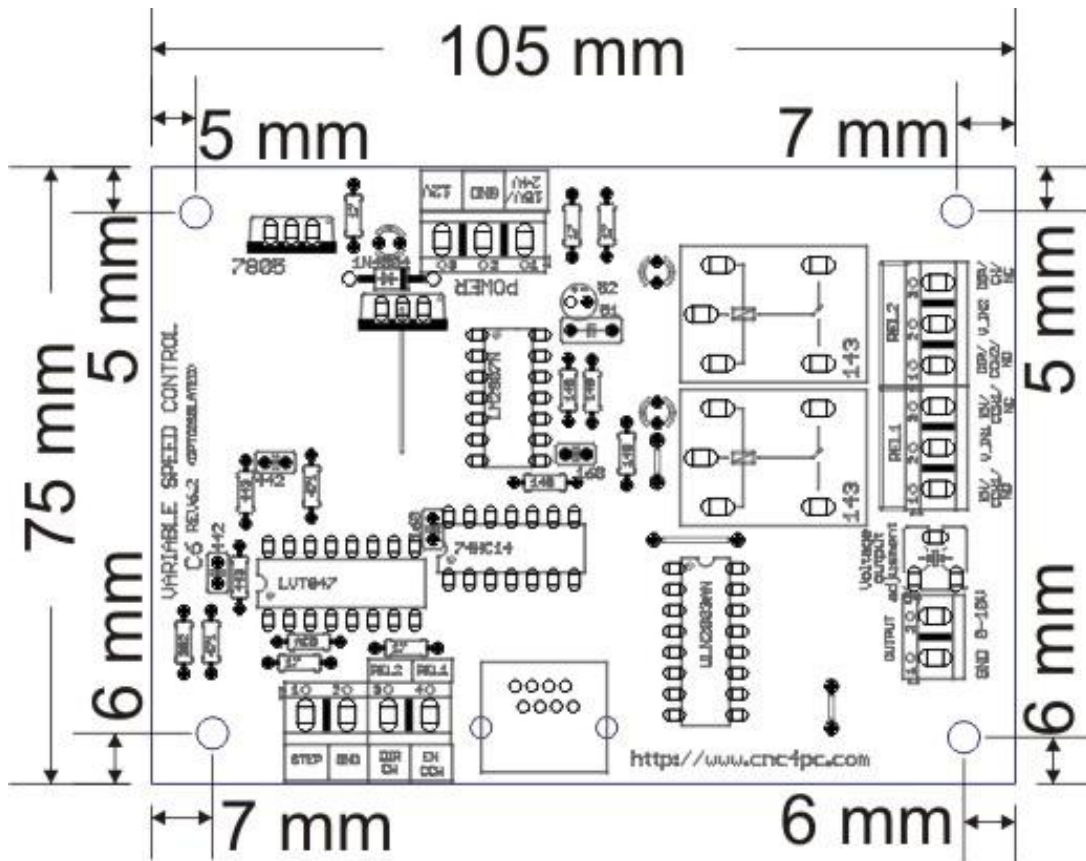

Fig. 4 C6 dimensions

Disclaimer

Use caution. CNC machines can be dangerous machines. Neither DUNCAN USA, LLC nor Arturo Duncan are liable for any accidents resulting from the improper use of these devices. This board is not a fail-safe device and it should not be used in life support systems or in other devices where its failure or possible erratic operation could cause property damage, bodily injury or loss of life.